

Operating Manual

Translation of the Original Operating Manual

FDL 115

Safety drying ovens
for drying of limited quantities of solvents

with microprocessor program controller RD3

Model	Model version	Art. No.
FDL 115 (E2.1)	FDL115-230V	9010-0292, 9110-0292

BINDER GmbH

- ▶ Address: Post office box 102, 78502 Tuttlingen, Germany ▶ Phone: +49 7462 2005 0
- ▶ Fax: +49 7462 2005 100 ▶ Internet: <http://www.binder-world.com>
- ▶ E-mail: info@binder-world.com ▶ Service Hotline: +49 7462 2005 555
- ▶ Service Fax: +49 7462 2005 93 555 ▶ Service E-Mail: customerservice@binder-world.com
- ▶ Service Hotline USA: +1 866 885 9794 or +1 631 224 4340 x3
- ▶ Service Hotline Asia Pacific: +852 390 705 04 or +852 390 705 03
- ▶ Service Hotline Russia and CIS: +7 495 988 15 16

Contents

1. SAFETY	4
1.1 Personnel Qualification	4
1.2 Operating manual	4
1.3 Legal considerations	4
1.3.1 Intellectual property	5
1.4 Structure of the safety instructions	5
1.4.1 Signal word panel	5
1.4.2 Safety alert symbol	6
1.4.3 Pictograms	6
1.4.4 Word message panel structure	7
1.5 Localization / position of safety labels on the chamber	7
1.6 Type plate	8
1.7 General safety instructions on installing and operating the chambers	9
1.8 Intended use	10
1.9 Foreseeable Misuse	12
1.10 Residual Risks	13
1.11 Operating instructions	14
1.12 Measures to prevent accidents	14
1.13 Important points to consider before commissioning	16
1.13.1 Technical ventilation / permissible load	16
1.13.2 Loading instructions	16
1.13.3 Drying nitro-cellulose lacquers	16
1.13.4 Drying mould varnishes	16
1.13.5 Drying impregnating resins	16
2. CHAMBER DESCRIPTION	17
2.1 Chamber overview	18
2.2 Control panel	19
2.3 Solvent diagram	19
2.4 Solvent diagram replacement on older devices	20
3. COMPLETENESS OF DELIVERY, TRANSPORTATION, STORAGE, AND INSTALLATION	20
3.1 Unpacking, and checking equipment and completeness of delivery	20
3.2 Guidelines for safe lifting and transportation	21
3.3 Storage	21
3.4 Location of installation and ambient conditions	21
4. INSTALLATION OF THE EQUIPMENT	23
4.1 Operating instructions	23
4.2 Electrical connection	23
4.3 Connection to a suction plant (optional)	24
5. START UP	25
5.1 Settings at the RD3 program controller	26
5.2 General indications	27
6. FIXED VALUE ENTRY MODE	28
7. WEEK PROGRAM EDITOR	29
7.1 Program table template for Week program Editor	31
8. PROGRAM EDITOR	32
8.1 Selecting between set-point ramp and set-point step	32
8.1.1 Programming with setting "Ramp" (default setting)	32
8.1.2 Programming with setting "step"	34
8.1.3 General notes on programming temperature transitions	35

8.2	Set-point entry for program operation	35
8.3	Program table template	38
8.4	Deleting a program section	39
9.	PROGRAM START LEVEL.....	40
10.	USER LEVEL	42
11.	BEHAVIOR IN CASE OF FAILURES.....	49
11.1	Behavior after a power failure	49
11.2	Alarm messages	49
12.	SAFETY DEVICES	49
12.1	Temperature safety device class 2	49
12.2	Exhaust air monitoring	51
13.	OPTIONS.....	52
13.1	APT-COM™ 4 Multi Management Software (option).....	52
13.2	Ethernet interface (available via BINDER INDIVIDUAL customized solutions).....	52
13.3	Coil-coating door flap (option).....	52
14.	CLEANING AND DECONTAMINATION	53
14.1	Cleaning	53
14.2	Decontamination / chemical disinfection.....	54
15.	MAINTENANCE AND SERVICE, TROUBLESHOOTING, REPAIR, TESTING... 56	
15.1	General information, personnel qualification.....	56
15.2	Maintenance intervals, service.....	56
15.3	Cleaning and replacing the intake filter.....	57
15.4	Simple troubleshooting.....	57
15.5	Sending the chamber back to BINDER GmbH	59
16.	DISPOSAL.....	60
16.1	Disposal of the transport packing.....	60
16.2	Decommissioning.....	60
16.3	Disposal of the chamber in the Federal Republic of Germany	60
16.4	Disposal of the chamber in the member states of the EU except for the Federal Republic of Germany.....	62
16.5	Disposal of the chamber in non-member states of the EU	63
17.	TECHNICAL DESCRIPTION.....	64
17.1	Factory calibration and adjustment	64
17.2	Definition of usable volume	64
17.3	Over current protection	64
17.4	FDL 115 technical data	64
17.5	Equipment and Options (extract)	66
17.6	Accessories and spare parts (extract)	67
17.7	Dimensions FDL 115.....	68
18.	CERTIFICATES AND DECLARATIONS OF CONFORMITY.....	69
18.1	EU Declaration of Conformity.....	69
18.2	Certificate for the GS mark of conformity of the “Deutsche Gesetzliche Unfallversicherung e.V.” (German Social Accident Insurance (DGUV)).....	72
19.	CONTAMINATION CLEARANCE CERTIFICATE	74
19.1	For chambers located outside USA and Canada	74
19.2	For chambers in USA and Canada	77

Dear customer,

For the correct operation of the chamber, it is important that you read this operating manual completely and carefully and observe all instructions as indicated. Failure to read, understand and follow the instructions may result in personal injury. It can also lead to damage to the chamber and/or poor equipment performance.

1. Safety

1.1 Personnel Qualification



The chamber must only be installed, tested, and started up by personnel qualified for assembly, startup, and operation of the chamber. Qualified personnel are persons whose professional education, knowledge, experience and knowledge of relevant standards allow them to assess, carry out, and identify any potential hazards in the work assigned to them. They must have been trained and instructed, and be authorized, to work on the chamber.

The chamber should only be operated by laboratory personnel especially trained for this purpose and familiar with all precautionary measures required for working in a laboratory. Observe the national regulations on minimum age of laboratory personnel.

1.2 Operating manual

This operating manual is part of the components of delivery. Always keep it handy for reference in the vicinity of the chamber. If selling the unit, hand over the operating manual to the purchaser.

To avoid injuries and damage observe the safety instructions of the operating manual. Failure to follow instructions and safety precautions can lead to significant risks.

	<div data-bbox="391 1077 1495 1167" style="background-color: red; color: white; padding: 5px;"> DANGER</div> <p data-bbox="391 1167 1495 1211">Dangers due to failure to observe the instructions and safety precautions.</p> <p data-bbox="391 1211 1495 1256">Serious injuries and chamber damage. Risk of death.</p> <ul data-bbox="391 1256 1495 1478" style="list-style-type: none">• Observe the safety instructions in this Operating Manual.• Follow the operating procedures in this Operating Manual.• Carefully read the complete operating instructions of the chamber prior to installing and using the chamber.• Keep the operating manual for future reference
---	--

	<p data-bbox="363 1507 1495 1590">Make sure that all persons who use the chamber and its associated work equipment have read and understood the Operating Manual.</p>
---	---

This Operating Manual is supplemented and updated as needed. Always use the most recent version of the Operating Manual. When in doubt, call the BINDER Service Hotline for information on the up-to-date-ness and validity of this Operating Manual.

1.3 Legal considerations

This operating manual is for informational purposes only. It contains information for correct and safe installing, start-up, operation, decommissioning, cleaning and maintenance of the product. Note: the contents and the product described are subject to change without notice.

Understanding and observing the instructions in this operating manual are prerequisites for hazard-free use and safety during operation and maintenance. Images are to provide basic understanding. They may deviate from the actual version of the chamber. The actual scope of delivery can, due to optional or special design, or due to recent technical changes, deviate from the information and illustrations in these instructions this operating manual. In no event shall BINDER be held liable for any damages, direct or incidental arising out of or related to the use of this manual.

This operating manual cannot cover all conceivable applications. If you would like additional information, or if special problems arise that are not sufficiently addressed in this manual, please ask your dealer or contact us directly, e.g. by phone at the number located on page one of this manual

Furthermore, we emphasize that the contents of this operating manual are not part of an earlier or existing agreement, description, or legal relationship, nor do they modify such a relationship. All obligations on the part of BINDER derive from the respective purchase contract, which also contains the entire and exclusively valid statement of warranty administration and the general terms and conditions, as well as the legal regulations valid at the time the contract is concluded. The statements in this manual neither augment nor restrict the contractual warranty provisions.

1.3.1 Intellectual property

Trademark Information: All BINDER trademarks relating to products or service, as well as trade names, logos and product names used on the website, products and documents of BINDER company are trademarks or registered trademarks of BINDER company (including BINDER GmbH, BINDER Inc.) in the U.S. and other countries and communities of states. This includes word marks, position marks, word/figurative marks, design configurations, figurative marks, and design patents.

Patent Information: BINDER products, categories of products, and accessories may be covered by one or more patents and/or utility models in the U.S. and other countries and communities of states. Additional patent applications may also be pending in the U.S. and other countries and communities of states.

Please visit www.binder-world.com for more information.

1.4 Structure of the safety instructions

In this operating manual, the following safety definitions and symbols indicate dangerous situations in accordance with ISO 3864-2 and ANSI Z535.6.

1.4.1 Signal word panel

Depending on the probability of serious consequences, potential dangers are identified with a signal word, the corresponding safety color, and if appropriate, the safety alert symbol.

 DANGER
Indicates an imminently hazardous situation that, if not avoided, will result in death or serious (irreversible) injury.

 WARNING
Indicates a potentially hazardous situation which, if not avoided, could result in death or serious (irreversible) injury.

 CAUTION
Indicates a potentially hazardous situation which, if not avoided, may result in moderate or minor (reversible) injury.

NOTICE
Indicates a potentially hazardous situation which, if not avoided, may result in damage to the product and/or its functions or of a property in its proximity.



















1.4.2 Safety alert symbol



Use of the safety alert symbol indicates a **risk of injury**.

Observe all measures that are marked with the safety alert symbol in order to avoid death or injury.

1.4.3 Pictograms

Warning signs			
 Electrical hazard	 Hot surface	 Explosive atmosphere	 Tipover hazard
 Inhalation hazard	 Risk of corrosion and / or chemical burns	 Harmful substances	 Biohazard
 Pollution Hazard			
Mandatory action signs			
 Mandatory regulation	 Read operating instructions	 Disconnect the power plug	 Lift with several persons
 Environment protection	 Wear protective gloves	 Wear safety goggles	
Prohibition signs			
 Do NOT touch	 Do NOT spray with water		



Information to be observed in order to ensure optimum function of the product.

1.4.4 Word message panel structure

Type / cause of hazard.

Possible consequences.

- ∅ Instruction how to avoid the hazard: prohibition
- Instruction how to avoid the hazard: mandatory action

Observe all other notes and information not necessarily emphasized in the same way, in order to avoid disruptions that could result in direct or indirect injury or property damage.

1.5 Localization / position of safety labels on the chamber

The following labels are located on the chamber:

Pictograms (Warning signs)	Service label
 <p>Hot surface</p>	



Figure 1: Position of labels on the chamber

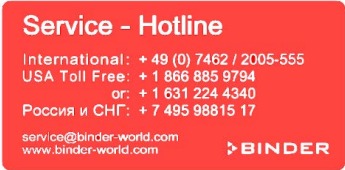

Keep safety labels complete and legible.

Replace safety labels that are no longer legible. Contact BINDER Service for these replacements.



1.6 Type plate



The type plate sticks to the left side of the chamber, bottom right-hand.

Nominal temp.	300 °C 572 °F	1,90 kW / 13,0 A 230 V / 50 Hz	   	Usable volume 0,115m ³ Steam space 0,156m ³ Max. solvent at nominal temp. 3,0g Min. exhaust flow rate 24m ³ /h at +20 °C Max. temp. of heating surfaces +750 °C Wiring diagram FDL 115 (E2.1)
IP protection	33	230 V / 60 Hz		
Safety device	DIN 12880	1 N PE ~		
Class	2.0			
Art. No.	9010-0292			
Project No.		Safety Drying Oven		
Built	2022			
		BINDER GmbH Im Mittleren Ösch 5 78532 Tuttlingen / Germany www.binder-world.com	FDL 115 E2.1	Serial No. 0000000000000 Made in Germany

Figure 2: Type plate (example of FDL 115 regular chamber)

Indications of the type plate		Information
BINDER		Manufacturer: BINDER GmbH
FDL 115		Model
Safety Drying Oven		Chamber name
Serial No.	000000000000	Serial no. of the chamber
Built	2022	Year of construction
Nominal temperature	300 °C 572 °F	Nominal temperature
IP protection	33	Type of IP protection acc. to standard EN 60529
Temp. safety device	DIN 12880	Temperature safety device acc. to standard DIN 12880:2007
Class	2.0	Class of temperature safety device
Art. No.	9010-0292	Art. no. of the chamber
Project No.	---	Optional: Special application acc. to project no.
2,90 kW		Nominal power
230 V 1 N PE ~		Nominal voltage 230 V ± 5%, single-phase unit
13,0 A		Nominal current
230 V / 50 Hz		Nominal voltage +/- 5% at the indicated power frequency
230 V / 60 Hz		
1 N ~		Current type
Usable volume 0,115m ³		Usable volume
Steam space 0,156m ³		Total steam space 0
Max. solvent at nominal temp. 3,0g		Highest permissible solvent quantity at 300 °C / 572°F
Min. exhaust flow rate 24m ³ /h at +20 °C		Minimum exhaust flow rate at +20 °C
Max. temp. of heating surfaces +750 °C		Maximum temperature of heating surfaces +750 °C / 1382°F
Wiring diagram FDL 115 (E2.1)		Wiring diagram of the chamber

Symbol on the type plate	Information
	CE conformity marking
 	Electrical and electronic equipment manufactured / placed on the market in the EU after 13 August 2005 and to be disposed of in a separate collection according to directive 2012/19/EU on waste electrical and electronic equipment (WEEE).

Symbol on the type plate	Information
	The chamber is certified according to Customs Union Technical Regulation (CU TR) for the Eurasian Economic Union (Russia, Belarus, Armenia, Kazakhstan Kyrgyzstan).
	GS mark of conformity of the “Deutsche Gesetzliche Unfallversicherung e.V. (DGUV), Fachausschuss Metall- und Oberflächenbehandlung, Prüf- und Zertifizierungsstelle im DGUV Test” (German Social Accident Insurance (DGUV), Expert Committee: Metal and Surface Treatment, Testing and Certification Body in DGUV)

1.7 General safety instructions on installing and operating the chambers



With regard to operating the chambers and to the installation location, please observe the local and national regulations relevant for your country (for Germany: DGUV guidelines 213-850 on safe working in laboratories, issued by the employers' liability insurance association).

BINDER GmbH is only responsible for the safety features of the chamber provided skilled electricians or qualified personnel authorized by BINDER perform all maintenance and repair, and if components relating to chamber safety are replaced in the event of failure with original spare parts.



To operate the chamber, use only original BINDER accessories or accessories from third-party suppliers authorized by BINDER. The user is responsible for any risk caused by using unauthorized accessories. .

NOTICE	
	<p>Danger of overheating due to lack of ventilation. Damage to the chamber.</p> <ul style="list-style-type: none"> ∅ Do NOT install the chamber in unventilated recesses. ➤ Ensure sufficient ventilation for dispersal of the heat. ➤ Observe the prescribed minimum distances when installing the chamber (chap. 3.4)

Do not install or operate the chamber in hazardous locations.



 DANGER	
	<p>Danger of explosion due to combustible dusts or explosive mixtures in the vicinity of the chamber.</p> <p>Serious injury or death from burns and / or explosion pressure.</p> <ul style="list-style-type: none"> ∅ Do NOT operate the chamber in potentially explosive areas. ➤ KEEP combustible dust or air-solvent mixtures AWAY from the chamber.

Familiarize yourself with any potential health risks caused by the charging material, the contained moisture constituent or by reaction products which may arise during the temperature process. Take adequate measures to exclude such risks prior to putting the safety drying oven into operation.



 DANGER	
	<p>Electrical hazard by water entering the chamber.</p> <p>Deadly electric shock.</p> <ul style="list-style-type: none"> ∅ The chamber must NOT become wet during operation, cleaning, or maintenance. ∅ Do NOT install the chamber in damp areas or in puddles. ➤ Set up the chamber in a way that it is splash-proof.

The chambers were produced in accordance with VDE regulations and were routinely tested in accordance to VDE 0411-1 (IEC 61010-1).

If a warning signal indicates an error condition, no further loading material must be introduced into the chamber.

	 DANGER
	<p>Explosion and ignition hazard due to introducing loading material when there is a warning message.</p> <p>Serious injury or death from burns and / or explosion pressure.</p> <p>∅ Do NOT introduce any further charging material as long as there is a warning signal.</p>

During and after the drying process, the inner surfaces have got a temperature close to the set-point. The inner chamber, the exhaust duct, the door gasket, and the access ports will become hot during operation.

	 CAUTION
	<p>Danger of burning by touching hot chamber parts during operation.</p> <p>Burns.</p> <p>∅ Do NOT touch the inner surfaces, the exhaust duct, the door gasket, the access ports, or the charging material during operation.</p>

1.8 Intended use

	<p>Following the instructions in this operating manual and conducting regular maintenance work (chap. 15) are part of the intended use.</p>
---	---

Any use of the chambers that does not comply with the requirements specified in this Operating Manual shall be considered improper use.

Other applications than those described in this chapter are not approved.

Use

The BINDER safety drying oven FDL 115 is suitable for drying and burn in of lacquers and similar liquid coating materials which are containing solvents that can form explosive mixtures with air. The maximally permitted drying temperature and the maximally permitted quantity of solvent are limited, see chap. 1.13. The chamber is also suited for coil coating / hot air short cycle applications.



Do NOT use the chamber to warm up coating materials in containers, vessels, etc. or for drying textiles soaked in solvent.

Do NOT use the chamber for drying purpose if greater quantities of steam or solvent gas leading to condensation will be set free.



Requirements for the chamber load

Any component of the charging material must NOT be able to release toxic gases.

The charging material shall not contain any corrosive ingredients that may damage the machine components made of stainless steel, aluminum, and copper. Such ingredients include in particular acids and halides. Any corrosive damage caused by such ingredients is excluded from liability by BINDER GmbH.

 	 DANGER
	<p>Explosion or implosion hazard and danger of poisoning through the introduction of unsuitable loading material.</p>
	<p>Poisoning. Serious injury or death from burns and / or explosion pressure.</p> <p>∅ Do NOT introduce any energy sources such as batteries or lithium-ion batteries</p> <p>∅ Do NOT introduce any substance which could lead to release of toxic gases.</p>

Contamination of the chamber by toxic, infectious or radioactive substances must be prevented.

	WARNING
 	<p>Danger of intoxication and infection through contamination of the chamber with toxic, infectious or radioactive substances.</p> <p>Damages to health.</p> <ul style="list-style-type: none"> ➤ Protect the interior of the chamber from contamination by toxic, infectious or radioactive substances. ➤ Take suitable protective measures when introducing and removing toxic, infectious or radioactive material

In case of foreseeable use of the chamber there is no risk for the user through the integration of the chamber into systems or by special environmental or operating conditions in the sense of EN 61010-1:2010. For this, the intended use of the chamber and all its connections must be observed.

Medical devices

The chambers are not classified as medical devices as defined by Regulation (EU) No 2017/745.

	<p>Due to the special demands of the Medical Products legislation, these chambers are not qualified to perform sterilization of medical devices as defined by Regulation (EU) No 2017/745.</p>
---	--

Personnel Requirements

Only trained personnel with knowledge of the Operating Manual can set up and install the chamber, start it up, operate, clean, and take it out of operation. Service and repairs call for further technical requirements (e.g. electrical know-how), as well as knowledge of the service manual.

Installation site requirements

The chambers are designed for setting up inside a building (indoor use).

The requirements described in the Operating Manual for installation site and ambient conditions (chap. 3.4) must be met.

1.9 Foreseeable Misuse

Other applications than those described in chap. 1.8 are not approved.

This expressly includes the following misuses (the list is not exhaustive), which pose risks despite the inherently safe construction and existing technical safety equipment:

- Non-observance of Operating Manual
- Non-observance of information and warnings on the chamber (e.g. control unit messages, safety identifiers, warning signals)
- Installation, startup, operation, maintenance and repair by untrained, insufficiently qualified, or unauthorized personnel
- Missed or delayed maintenance and testing
- Non-observance of traces of wear and tear
- Insertion of materials excluded or not permitted by this Operating Manual.
- Insertion of solvent when there is a warning message
- Exceeding the permissible solvent quantities
- Exceeding the permissible drying temperature
- Non-compliance with the admissible parameters for processing the respective material.
- Installation, testing, service or repair in the presence of solvents
- Installation of replacement parts and use of accessories and operating resources not specified and authorized by the manufacturer
- Installation, startup, operation, maintenance or repair of the chamber in absence of operating instructions
- Bypassing or changing protective systems, operation of the chamber without the designated protective systems
- Non-observance of messages regarding cleaning and disinfection of the chamber.
- Spilling water or cleaning agent on the chamber, water penetrating into the chamber during operation, cleaning or maintenance.
- Cleaning activity while the chamber is turned on.
- Operation of the chamber with a damaged housing or damaged power cord
- Continued operation of the chamber during an obvious malfunction
- Insertion of objects, particularly metallic objects, in louvers or other openings or slots on the chamber
- Human error (e.g. insufficient experience, qualification, stress, exhaustion, laziness)

To prevent these and other risks from incorrect operation, the operator shall issue operating instructions. Standard operating procedures (SOPs) are recommended.

1.10 Residual Risks

The unavoidable design features of a chamber, as well as its proper field of application, can also pose risks, even during correct operation. These residual risks include hazards which, despite the inherently safe design, existing technical protective equipment, safety precautions and supplementary protective measures, cannot be ruled out.

Messages on the chamber and in the Operating Manual warn of residual risks. The consequences of these residual risks and the measures required to prevent them are listed in the Operating Manual. Moreover, the operator must take measures to minimize hazards from unavoidable residual risks. This includes, in particular, issuing operating instructions.

The following list summarizes the hazards against which this Operating Manual and the Service Manual warn, and specifies protective measures at the appropriate spots:

Unpacking, Transport, Installation

- Sliding or tilting the chamber
- Setup of the chamber in unauthorized areas
- Installation of a damaged chamber
- Installation of a chamber with damaged power cord
- Inappropriate site of installation
- Absent or insufficient ventilation in the installation area
- Missing protective conductor connection
- Unsuitable suction installation

Normal operation

- Assembly errors
- Contact with hot surfaces on the housing
- Contact with hot surfaces in the interior and inside of doors
- Emission of non-ionizing radiation from electrical operating resources
- Contact with live parts in normal state

Cleaning and Decontamination

- Penetration of water into the chamber
- Inappropriate cleaning and decontamination agents
- Enclosure of persons in the interior

Malfunction and Damage

- Continued operation of the chamber during an obvious malfunction or outage of the heating system
- Contact with live parts during error status
- Operation of a unit with damaged power cord

Maintenance

- Maintenance work on live parts.
- Execution of maintenance work by untrained/insufficiently qualified personnel
- Electrical safety analysis during annual maintenance not performed

Trouble-shooting and Repairs

- Non-observance of warning messages in the Service Manual
- Trouble-shooting of live parts without specified safety measures

- Absence of a plausibility check to rule out erroneous inscription of electrical components
- Performance of repair work by untrained/insufficiently qualified personnel
- Inappropriate repairs which do not meet the quality standard specified by BINDER
- Use of replacement parts other than BINDER original replacement parts
- Electrical safety analysis not performed after repairs

1.11 Operating instructions

Depending on the application and location of the chamber, the operator of the safety drying oven must provide the relevant information for safe operation of the chamber in a set of operating instructions.



These operating instructions must be kept with the chamber at all times in a place where they are clearly visible. They must be comprehensible and written in the language of the employees.

1.12 Measures to prevent accidents

The operator of the chamber must observe the local and national regulations and take precautions to prevent accidents.

During drying of fluid paints, flammable solvent/air mixtures can form and ignite.

The manufacturer took the following measures to prevent ignition and explosions:

- **Indications on the type plate**

See operating manual chap. 1.6

- **Operating manual**

An operating manual is available for each safety drying oven.

A diagram in the operating manual (chap. 2.3) indicates the maximum permissible solvent quantities for various operating states.

The operating manual asks the operator of the safety drying oven to set up an instruction on the permissible loading quantity.

- **Maximum temperatures and maximum permissible steam concentration**

By means of the diagram “Highest permissible solvent quantity”, which is included in the operating manual chap. 2.3 and applied on the front of the safety drying oven, the operator must adapt the drying temperature to the maximum solvent quantity arising.

When using nitro-cellulose lacquers or nitro combination lacquers, the diagram “Highest permissible solvent quantity” specifies a limit temperature of max. 130 °C/ 266 °F, which must not be exceeded. (In this context, all paints containing more than 5 % nitro-cellulose relative to the non-volatile contents are regarded as nitro-cellulose lacquers and nitro-combination lacquers).

A gas-tight separation between the drying chamber and the heating chamber is not necessary since there is an effective forced air motion in the entire steam room.

- **Throttle valves**

No throttle valves are used, i.e., the full air change occurs permanently.

- **Protecting the heating surfaces against dripping**

All heating elements are protected against lacquer dripping and direct contact with lacquer coatings.

- **Heat insulation**

All heat insulation is sealed against penetration by lacquer vapors from the outside with high temperature-resistant and ageing-resistant sealant.

The insulation material consists of non-combustible mineral wool (class A1 according to DIN 4102-1:1998).

- **Overtemperature monitoring**

The safety drying oven is equipped with a temperature display, which can be read from outside.

A built-in additional temperature safety device can turn off the heating and is functionally independent of the main controller. When turning off the chamber, the forced convection and the control equipment's function are maintained.

Visual (red indicator light) and audible (buzzer) signals indicate temperature exceeding.

- **Monitoring the stream of exhaust air during prepurge**

The chamber complies with the requirements on monitoring the pressure switch according to EN 1539:2015 and EN ISO 13849:2015.

The fan only turns on after pressing pushbutton "START" (4).

After approx. 2 minutes of prepurge with monitoring the stream of exhaust air the heating turns on.

- **Door switch**

If the door is opened briefly (less than 2 minutes) the heating turns off. When opening the door for longer than 2 minutes, fan and heating turn off. To restart the drying process in this case, new prepurge is required.

- **Safety in case the technical ventilation fails**

The heating only turns on if the air circulation is already in operation.

If the air circulation fails, the heating immediately turns off. In addition, there is a visual signal: red indicator light "AIR" (3). As an additional indication there is an acoustical signal which can be reset on the controller.

- **Moving parts participating in the work process**

It is impossible to touch the fan from outside the device or from the interior.

- **Safety, measurement and control devices**

The safety, measuring, and control equipment is easily accessible via the housing top cover.

- **Electrostatic charge**

The interior parts are grounded.

- **Protection against touchable surfaces**

Tested according to EN ISO 13732-1:2008.

- **Floors**

See operating manual chap. 3.4 for the oven's installation.

- **Ventilation**

Ventilation shall be realized by the operator according to GUV-R 500 chap. 2.29 "Verarbeiten von Beschichtungsstoffen" (Processing of paints) (for Germany).

- **Cleaning**

See operating manual chap. 14.

- **Examinations**

The safety drying oven has been inspected by the "Deutsche Gesetzliche Unfallversicherung e.V. (DGUV), Fachausschuss Nahrungs- und Genussmittel, Prüf- und Zertifizierungsstelle im DGUV Test" (German Social Accident Insurance (DGUV), Expert Committee: "Metal and Surface Treatment", Testing and Certification Body in DGUV) and bears the GS mark.

1.13 Important points to consider before commissioning

1.13.1 Technical ventilation / permissible load

For safety reasons, the formation of a dangerous, explosive atmosphere must be avoided in all operating modes (see GUV-R 500 chap. 2.28 "Betreiben von Trocknern für Beschichtungsstoffe" ("Dryers for coating materials")). Keeping the maximum permissible amount of solvent when loading the chamber will meet this requirement. The permissible quantity can be calculated according to the "principles for the calculation of ventilation of chamber dryers and continuous dryers" (EN 1539:2015, Appendix B). According to this standard, the safety drying oven's technical data (chap. 17.4) must be included in the calculation, and it is required to set up a set of loading instructions (for Germany).

1.13.2 Loading instructions

The loading instructions should specify the amount of material, which can be loaded into the safety drying oven for treatment without any risk of creating a dangerous, explosive atmosphere. GUV-R 500 chap. 2.28 "Betreiben von Trocknern für Beschichtungsstoffe" ("Dryers for coating materials") explicitly states that the operator must set up a set of loading instructions (for Germany).

1.13.3 Drying nitro-cellulose lacquers

When using the safety drying oven FDL to dry material, which is coated with nitro-cellulose lacquers, the temperature safety device must be set to **max. 130 °C / 266 °F**, so that the surface temperature of the goods to be dried is ensured not to exceed 130 °C / 266 °F. Deviations are only permissible if a report from a testing agency, which is recognized by the employer's liability insurance association, has declared safe a higher surface temperature.

1.13.4 Drying mould varnishes

When using the safety drying oven FDL to dry mould varnishes, the operator is allowed to increase the highest permissible amount of solvent specified for surface drying (chap. 2.3) by up to 10 times (see GUV-R 500 chap. 2.28 "Betreiben von Trocknern für Beschichtungsstoffe" ("Dryers for coating materials") or EN 1539:2015, Appendix A.1.2).

1.13.5 Drying impregnating resins

When using the safety drying oven FDL to dry impregnating resins, the operator is allowed to increase the highest permissible amount of solvent specified for surface drying (chap. 2.3) by up to 20 times (see GUV-R 500 chap. 2.28 "Betreiben von Trocknern für Beschichtungsstoffe" ("Dryers for coating materials") no. 3.7.4 or EN 1539:2015, Appendix A.1.2).

2. Chamber description

The safety drying oven FDL 115 was built according to EN 1539:2015 (“Dryers and ovens, in which flammable substances are released. Safety requirements”).

The fan in the rear of the safety drying oven delivers a constant amount of fresh air through the working area irrespective of the drying temperature. A large-area filter removes dust from the incoming air (permeability up to approx. 1 micrometer).

A flow monitor in the upper part of the device (pressure differential switch) monitors the stream of exhaust air. In the event of failure, the monitoring system turns the heater off immediately and shows this status with a visual signal: red indicator light “AIR” (3) (see Figure 4).

After turning on the chamber with the main power switch, pressing the “START” pushbutton will start the fan and the prepurge procedure. The indicator light “AIR” (3) in the operating panel lights up as long as the heating has not yet been released by the air-flow monitoring. As an additional indication there is an acoustical signal which can be reset on the controller with the “EXIT” key. The chamber heating is released after approx. 2 minutes of prepurge with monitoring the stream of exhaust air.

If during drying operation the door is opened briefly (less than 2 minutes) the heating turns off, but there is no disconnection of the fan. After closing the door, the drying process continues automatically. If the door is opened for longer (more than 2 minutes), fan and heating turn off. To release the heating and restart the drying process, new prepurge is required.

The drying temperature is also monitored constantly by the temperature safety device (2). In case the temperature exceeds the maximum permissible temperature, the heating will be turned off immediately and this status registered by an audible and a visual signal – indicator light (2a). In case of failure, it is impossible to restart the drying oven before the reset key (2b) was reset.

BINDER safety drying ovens with forced convection FDL are equipped with the electronic program controller RD3 with digital display. This permits programming of temperature cycles.

The APT.line™ heating system ensures high level of spatial and time-based temperature precision, thanks to the direct and distributed air circulation into the interior. The fan supports exact attainment and maintenance of the required temperature accuracy.

All functions of the multifunctional program control can be set simply and conveniently via the easy to understand function keypad of the RD3 temperature program controller. This controller is equipped with touch function keys and a digital display and permits exact temperature setting and programming temperature cycles. The FDL provides almost unlimited possibilities of adapting to individual customer requirements based upon extensive programming options and on the week program timer and real time clock of the controller.

All chamber functions are easy and comfortable to use thanks to their clear arrangement. Major features are easy cleaning of all chamber parts and avoidance of undesired contamination.

The inner chamber and the interior side of the doors are made of stainless steel V2A (German material no. 1.4301, US equivalent AISI 304). When operating the chamber at temperatures above 150 °C, the impact of the oxygen in the air may cause discoloration of the metallic surfaces (yellowish-brown or blue) by natural oxidation processes. These colorations are harmless and will in no way impair the function or quality of the chamber. The housing is RAL 7035 powder-coated. All corners and edges are also completely coated.

The safety drying oven FDL comes equipped with a serial interface RS 422 for computer communication, e.g. via the APT-COM™ 4 Multi Management Software (option, chap. 13.1). For further options, see chap. 17.5.

The chambers can be operated at an ambient temperature of 18 °C / 64.4 °F up to 40 °C / 104 °F in a temperature control range by 5 °C above ambient temperature up to +300 °C / 572 °F.

2.1 Chamber overview

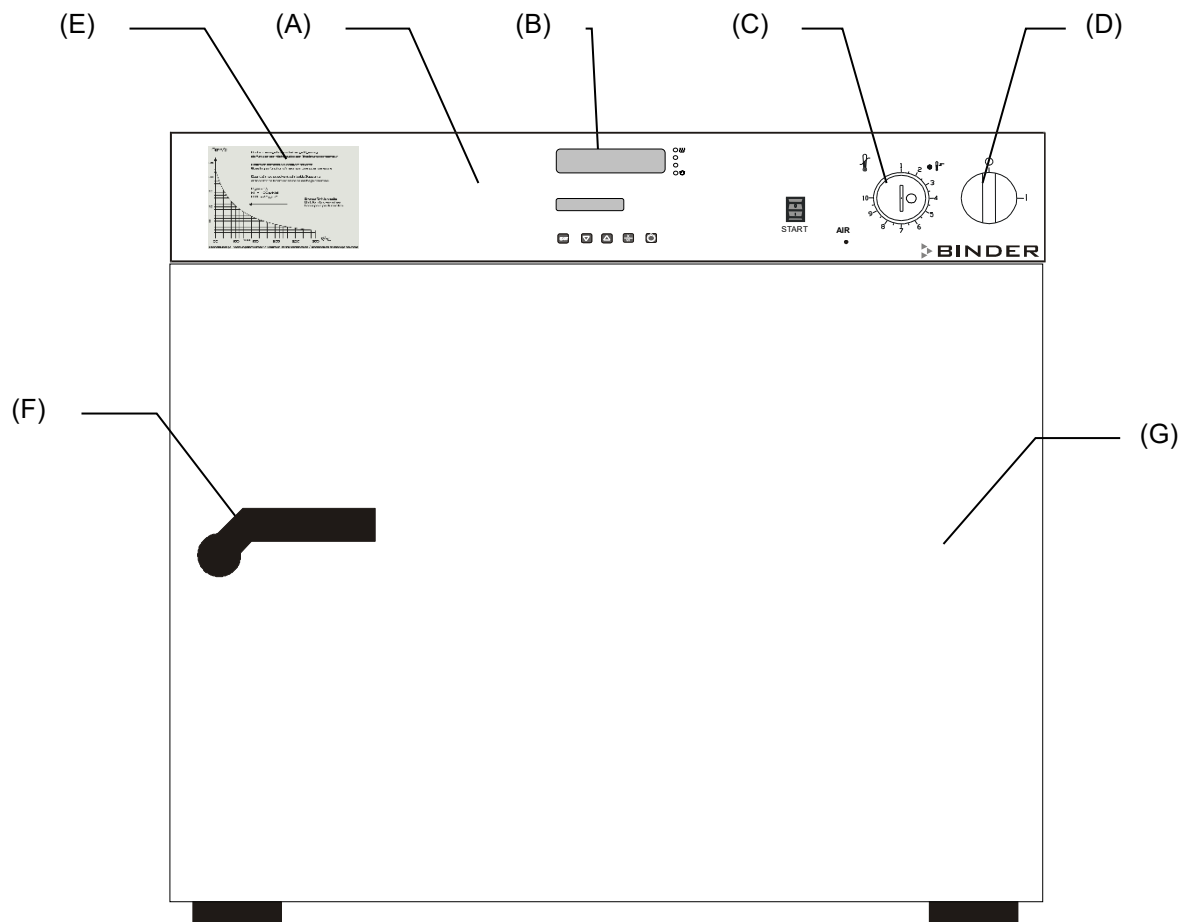

Figure 3: FDL 115 front view

- (A) Control panel
- (B) Microprocessor program controller RD3
- (C) Temperature safety device class 2 according to DIN 12880:2007
- (D) Main power switch ON/OFF
- (E) Solvent diagram
- (F) Door handle
- (G) Chamber door

2.2 Control panel

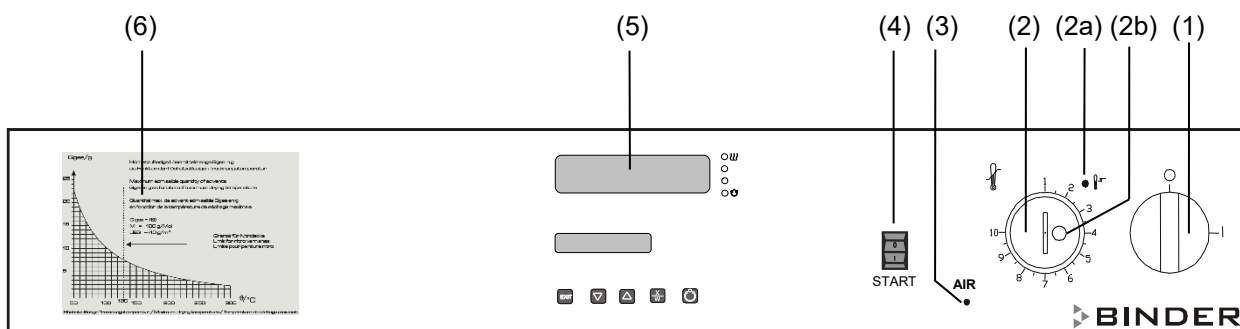

Figure 4: Control panel of FDL 115 standard chamber

- (1) Main power switch ON/OFF
- (2) Temperature safety device class 2
- (2a) Red pilot lamp for temperature safety device class 2
- (2b) RESET key for temperature safety device
- (3) Red indicator light "AIR": Heating turned off during prepurge or due to insufficient exhaust air stream (loss of technical ventilation)
- (4) Pushbutton "START": starts the fan and the prepurge procedure
- (5) Temperature program controller RD3
- (6) Solvent diagram: Highest permissible amount of solvent G_{total} [g] as a function of the drying temperature

2.3 Solvent diagram

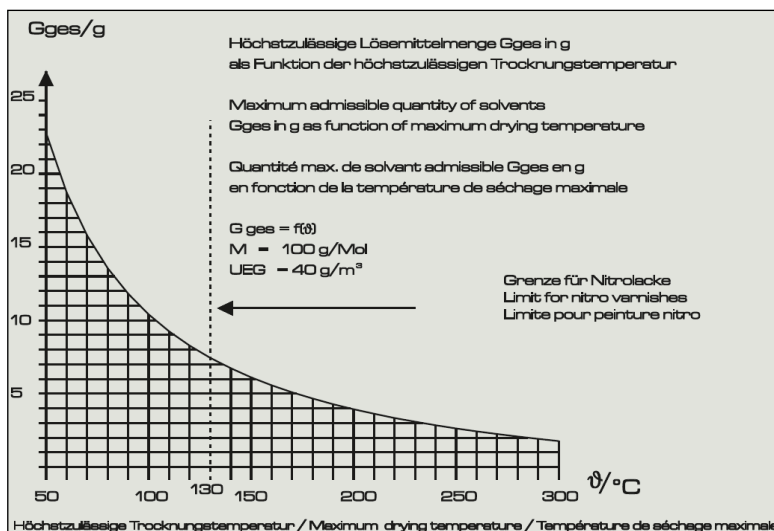



Figure 5: FDL 115 solvent diagram

The diagram shows the highest permissible solvent quantity G_{total} [g] in the steam room in correspondence to the drying temperature. This is based on the calculation acc. to EN 1539:2015 considering the chamber specific data, an assumed molecular weight of the solvent of 100g/Mol, and a lower explosion limit of 40g/m³ at 20 °C / 68 °F and at 760 Torr (1013 hPa) (assumptions for unknown solvents acc. to EN 1539:2015).

In case of too high drying temperature and /or too high quantity of solvent in the steam room it could be possible that the concentration of the solvent steam will lead to an explosion. The permitted maximum of solvent brought into the drying oven and the maximal temperature must not be exceeded.

	 DANGER
	<p>Danger of explosion due to excessive drying temperature and/or excessive solvent quantity.</p> <p>Serious injury or death from burns and / or explosion pressure.</p> <ul style="list-style-type: none"> ∅ Do NOT exceed the maximum solvent quantity. ∅ Do NOT exceed the maximum drying temperature for the solvent quantity.

Adjust the temperature safety device according to the selected set-point (chap. 12.1).

2.4 Solvent diagram replacement on older devices

	Modified solvent diagram from ser.no. 2018xxxxxx6321on.
---	---

Note for older devices:

The solvent diagram must be replaced on the following FDL ovens:

- Serial no. type xx-xxxxx
- Serial no. 2017xxxxxxxxxx up to 2018xxxxxx6320

Receive a free replacement sticker (art. no. 6001-0522) from BINDER Service. Stick it over the existing solvent diagram.



3. Completeness of delivery, transportation, storage, and installation

3.1 Unpacking, and checking equipment and completeness of delivery

After unpacking, please check the chamber and its optional accessories, if any, based on the delivery receipt for completeness and for transportation damage. Inform the carrier immediately if transportation damage has occurred.

The final tests of the manufacturer may have caused traces of the shelves on the inner surfaces. This has no impact on the function and performance of the chamber.

Please remove any transportation protection devices and adhesives in/on the chamber and on the doors and remove the operating manuals and accessory equipment.

 	 CAUTION
	<p>Risk of injury and damages by lifting heavy loads and by sliding or tilting of the chamber due to improper lifting.</p> <p>Injuries, damage to the chamber.</p> <ul style="list-style-type: none"> ∅ Do NOT lift or transport the chamber using the door or the handle. ➤ Lift the chamber from the pallet at the four lower corners with the aid of four people.

If you need to return the chamber, please use the original packing and observe the guidelines for safe lifting and transportation (chap. 3.2).

For disposal of the transport packing, see chap. 16.1.





Note on second-hand chambers (Ex-Demo-Units):

Second-hand chambers are chambers that were used for a short time for tests or exhibitions. They are thoroughly tested before resale. BINDER ensures that the chamber is technically sound and will work flawlessly.

Second-hand chambers are marked with a sticker on the chamber door. Please remove the sticker before commissioning the chamber.

3.2 Guidelines for safe lifting and transportation

After operation, please observe the guidelines for temporarily decommissioning the chamber (chap. 16.2).

  	 CAUTION
<p>Risk of injury and damages by lifting heavy loads and by sliding or tilting of the chamber due to improper transportation.</p> <p>Injuries, damage to the chamber.</p> <ul style="list-style-type: none"> ⊘ Do NOT lift or transport the chamber using the door or the handle. ➤ Transport the chamber in its original packaging only. ➤ For moving or shipping, secure the oven with transport straps. ➤ Lift the chamber at the four lower corners with the aid of 4 people and place it on a transport pallet with wheels. Push the pallet to the desired site and then lift the chamber at its four lower corners from the pallet with the aid of four people. 	

- Permissible ambient temperature range during transport: -10 °C / 14 °F to +60 °C / 140 °F.

You can order transport packing and pallets for moving or shipping purposes from BINDER service.

3.3 Storage

Intermediate storage of the chamber is possible in a closed and dry room. Observe the guidelines for temporary decommissioning (chap. 16.2).

- Permissible ambient temperature range during storage: -10 °C / 14 °F to +60 °C / 140 °F.
- Permissible ambient humidity: max. 70 % r.h., non-condensing



When after storage in a cold location you transfer the chamber to its warmer installation site, condensation may form. Before start-up, wait at least one hour until the chamber has attained ambient temperature and is completely dry.

3.4 Location of installation and ambient conditions

Set up the safety drying oven FDL on a flat, even and non-flammable surface, free from vibration and in a well-ventilated, dry location and align it using a spirit level. The site of installation must be capable of supporting the chamber's weight (see technical data, chap. 17.4). The chambers are designed for setting up inside a building (indoor use).

	NOTICE
	<p>Danger of overheating due to lack of ventilation.</p> <p>Damage to the chamber.</p> <ul style="list-style-type: none"> ∅ Do NOT install the chamber in unventilated recesses. ➤ Ensure sufficient ventilation for dispersal of the heat. ➤ Observe the prescribed minimum distances when installing the chamber.

Do not install or operate the chamber in potentially explosive areas.

	 DANGER
	<p>Danger of explosion due to combustible dusts or explosive mixtures in the vicinity of the chamber.</p> <p>Serious injury or death from burns and / or explosion pressure.</p> <ul style="list-style-type: none"> ∅ Do NOT install the chamber in potentially explosive areas. ➤ KEEP explosive dust or air-solvent mixtures AWAY from the vicinity of the chamber.

Ambient conditions

- Permissible ambient temperature range during operation: +18 °C / 64.4 °F up to +40 °C / 104 °F. At elevated ambient temperature values, fluctuations in temperature can occur.



The ambient temperature should not be substantially higher than the indicated ambient temperature of +22 °C +/- 3 °C / 71.6 °F +/- 5.4 °F to which the specified technical data relate. Deviations from the indicated data are possible for other ambient conditions.

- Permissible ambient humidity: 70 % r.h. max., non-condensing.
- Installation height: max. 2000 m / 6562 ft. above sea level.

Minimum distances

- When placing several chambers of the same size side by side, maintain a minimum distance of 250 mm / 9.84 in between each chamber.
- Wall distances: rear 100 mm / 3.9 in, sides 160 mm / 6.29 in.
- Spacing above the chamber of at least 100 mm / 3.9 in must also be accounted for.

The chambers are NOT intended for stacking.

	NOTICE
	<p>Danger by stacking.</p> <p>Damage to the chambers.</p> <ul style="list-style-type: none"> ∅ Do NOT place the chambers on top of each other.



Other requirements

To completely separate the chamber from the power supply, you must disconnect the power plug. Install the chamber in a way that the power plug is easily accessible and can be easily pulled in case of danger.

The safety drying oven FDL with housing protection IP 33 acc. to DIN 40050 (see type plate) must NOT be installed and operated in explosive and fire-endangered areas.

Operation of the cooling slots must on no account be impaired. The vapors produced when the heating the content must be extracted from the safety drying oven through non-combustible exhaust gas or exhaust air ducts. The exhaust duct (nominal diameter 100 mm / 3.9 in) on the rear of the chamber serves for this purpose, to which a suitable exhaust air duct can be connected, e.g., a corrugated aluminum hose. The exhaust connection must be made via a draught limiter; the exhaust air must not be guided into ducts for combustible gas.

The rear exhaust duct will become hot during operation.

	 CAUTION
	<p>Danger of burning by touching the rear exhaust duct during operation.</p> <p>Burns.</p> <p>∅ Do NOT touch the exhaust duct during operation.</p>

4. Installation of the equipment

4.1 Operating instructions



Depending on the application and location of the chamber, the operator of the safety drying oven must provide the relevant information for safe operation of the chamber in a set of operating instructions.

	<p>Keep these operating instructions with the chamber at all times in a place where they are clearly visible. They must be comprehensible and written in the language of the employees.</p>
---	---

4.2 Electrical connection

The safety drying oven FDL 115 is supplied ready for connection.

- Power connection: fixed power connection cable 1800 mm / 5.9 ft in length with a grounded plug.
- Power supply voltage 230 V +/- 5 % at 50 Hz, 230 V +/- 5 % at 60 Hz. Current type 1N~
- The domestic socket must also provide a protective conductor. Make sure that the connection of the protective conductor of the domestic installations to the chamber's protective conductor meets the latest technology. The protective conductors of the socket and plug must be compatible!

	 DANGER
	<p>Electrical hazard due to missing protective conductor connection.</p> <p>Deadly electric shock.</p> <p>➤ Make sure that the chamber's power plug and the power socket match and securely connect the electrical protective conductors of the chamber and the house installation.</p>

- Housing protection type according to EN 60529:2000: IP 33
- Electrical protection: protection class I (with grounding conductor connection)
- Prior to connection and start-up, check the power supply voltage. Compare the values to the specified data located on the chamber's type plate (chamber front behind the door, bottom left-hand, see chap. 1.6).

	NOTICE
	<p>Danger of incorrect power supply voltage due to improper connection.</p> <p>Damage to the chamber.</p> <p>➤ Check the power supply voltage before connection and start-up.</p> <p>➤ Compare the power supply voltage with the data indicated on the type plate.</p>

- When connecting, please observe the regulations specified by the local electricity supply company as well as the local or national electrical regulations (VDE directives for Germany).

- Observe a sufficient current protection according to the number of devices that you want to operate. We recommend the use of a residual current circuit breaker.
- Pollution degree (acc. to IEC 61010-1): 2
- Over-voltage category (acc. to IEC 61010-1): II

See also electrical data (chap. 17.4).



To completely separate the chamber from the power supply, you must disconnect the power plug. Install the chamber in a way that the power plug is easily accessible and can be easily pulled in case of danger.

4.3 Connection to a suction plant (optional)

When directly connecting a suction plant the spatial temperature exactitude, the heating-up and the recovering times and the maximum temperature will be negatively influenced. So, no suction plant should be directly connected to the exhaust duct (nominal diameter 100 mm / 3.9 in) on the rear of the chamber. Connect a suitable exhaust air duct, e.g., a corrugated aluminum hose, to the chamber exhaust duct. The exhaust connection must be made via a draught limiter; the exhaust air must not be guided into ducts for combustible gas.



Active suction from the oven must only be performed together with extraneous air. Perforate the connecting piece to the suction device or place an exhaust funnel at some distance to the exhaust duct.

The rear exhaust duct will become hot during operation.



CAUTION

Danger of burning by touching the rear exhaust duct during operation.

Burns.

⊘ Do NOT touch the exhaust duct during operation.

5. Start up

After connecting the electrical supply (chap. 4.2), you can turn on the chamber.

After loading the chamber, close the chamber door.

- Turn on the chamber by setting the main power switch (1) to position “I”.

Indicator light “AIR” (3) is lit, indicating that the heating has not yet been released by the air flow monitoring.

As an additional indication there is an acoustical signal which can be reset on the controller with the “EXIT” key. The visual indication “RESET ALARM” on the controller is shown until the prepurge is over and the heating has turned on.

(If the chamber was turned off after reset of the acoustical signal but still during prepurge or if the door was opened, there is no further acoustical signal after turning on the chamber again.)

- Press pushbutton “START” (4). The fan starts running.

As required acc. to EN 1539:2015, the exhaust air flow is continuously monitored during prepurge of the interior.

After approx. 2 minutes of prepurge, the heating is enabled; and the indicator light “AIR” (3) turns off.

Now you can also reset the visual indication “RESET ALARM” on the controller with the “EXIT” key.

- Set the temperature set point (chap. 6).

When loading the oven with solvent-containing material, do not exceed the maximally permitted solvent quantity for the selected drying temperature. Refer to the solvent diagram on the oven front, chap. 2.3.

- Adjust the temperature safety device according to the selected set-point (chap. 12.1).

Detach the plastic cover over the temperature safety device class 2 (2) with a suitable Phillips screwdriver, and then set the temperature safety device (2) to the maximum permissible drying temperature (chap. 12.1) and restore the plastic cover to prevent misadjusting.

After reaching the set drying temperature, the heating keeps it constant by turning on and off regularly. You can verify this on the controller display.

Behavior after door opening during drying operation:

- If the door is opened briefly (less than 2 minutes) the heating turns off, but there is no disconnection of the fan. After closing the door, the drying process continues automatically.
- If the door is opened for longer (more than 2 minutes), fan and heating turn off, so that the drying process is interrupted. The indicator light “AIR” (3) lights up, and as an additional indication there is an acoustical signal which can be reset on the controller. To release the heating and restart the drying process, new prepurge is required: press pushbutton “START” (4).

Warming chambers may release odors in the first few days after commissioning. This is not a quality defect. To reduce odors quickly we recommend heating up the chamber to its nominal temperature for one day and in a well-ventilated location.

5.1 Settings at the RD3 program controller

After turning the chamber on with the main power switch (1), pressing pushbutton “START” (4) and completing the prepurge, the controller is in Normal Display / fixed value operation mode.

Depending on the temperature value entered before LED (3a) is lit if the heating is active, or no LED if the actual temperature is equal to or above the set-point.

In **Display 1** of the controller the actual temperature Value is shown.

- With inactive week program timer:

In **Display 2** of the controller the actual date and time are displayed. Example:

15.01.07 13:52

- With active week program timer:

In **Display 2** of the controller the actual date and time and the states of the week program timer channels are displayed. Examples:

15.01.07 13:52 --	15.01.07 13:52 - □	15.01.07 13:52 □ -	15.01.07 13:52 □ □
Channel 1 Off, Channel 2: Off	Channel 1: Off, Channel 2: On	Channel 1: On, Channel 2: Off	Channel 1 On, Channel 2: On

Display 1

Display 2



- (3a) LED Heating active
- (3b) (no function)
- (3c) (no function)
- (3d)
LED lit: program operation
LED flashing: exceeding of the tolerance limits in “Fixed value entry mode” or in “Program operation”. In program operation: program interruption.

Figure 6: RD3 program controller

The program controller RD3 permits programming of temperature cycles.

Two programs with up to 10 sections each or one program with up to 20 sections can be entered (setting in the user level, chap. 10).

When changing from 2 programs to 1 program or vice-versa, existing programs are deleted

The maximum length of an individual program section can be set to either 99 hs 59 min or to 999 hs 59 min (setting in the user level, chap. 10). This setting is then valid for all program sections.

Programming can be done directly via the controller keyboard or graphically at the computer using the APT-COM™ 4 Multi Management Software (option, chap. 13.1) specially developed by BINDER.

5.2 General indications

The program controller RD3 offers several functional levels:

Normal Display / fixed value operation:

- Display of the actual value of temperature (display 1) and of the actual date and time (display 2).
- The chamber is in fixed value operating mode, adjusting to the entered set-points.

Fixed value entry mode (chap. 6)

- Entry of the temperature set-point for fixed value operating mode
- Entry of temperature set-points 1 and 2 for week program operation

Program editor (chap. 8)

- Two programs with up to 10 sections each or one program with up to 20 sections can be entered (selection in the user level, chap. 10). Entry of temperature set-points in all program sections (chap. 8.2).
- Deleting a program section (chap. 8.4)

Program start level (chap. 9)

- Selection of an entered program
- Entry of settings affecting the program course, as “start delay time” or “number of program cycles”
- Program start

Week program editor (chap.7)

- Setting the shift points

User level (chap. 10)

- User specific controller settings
- Setting the real time clock

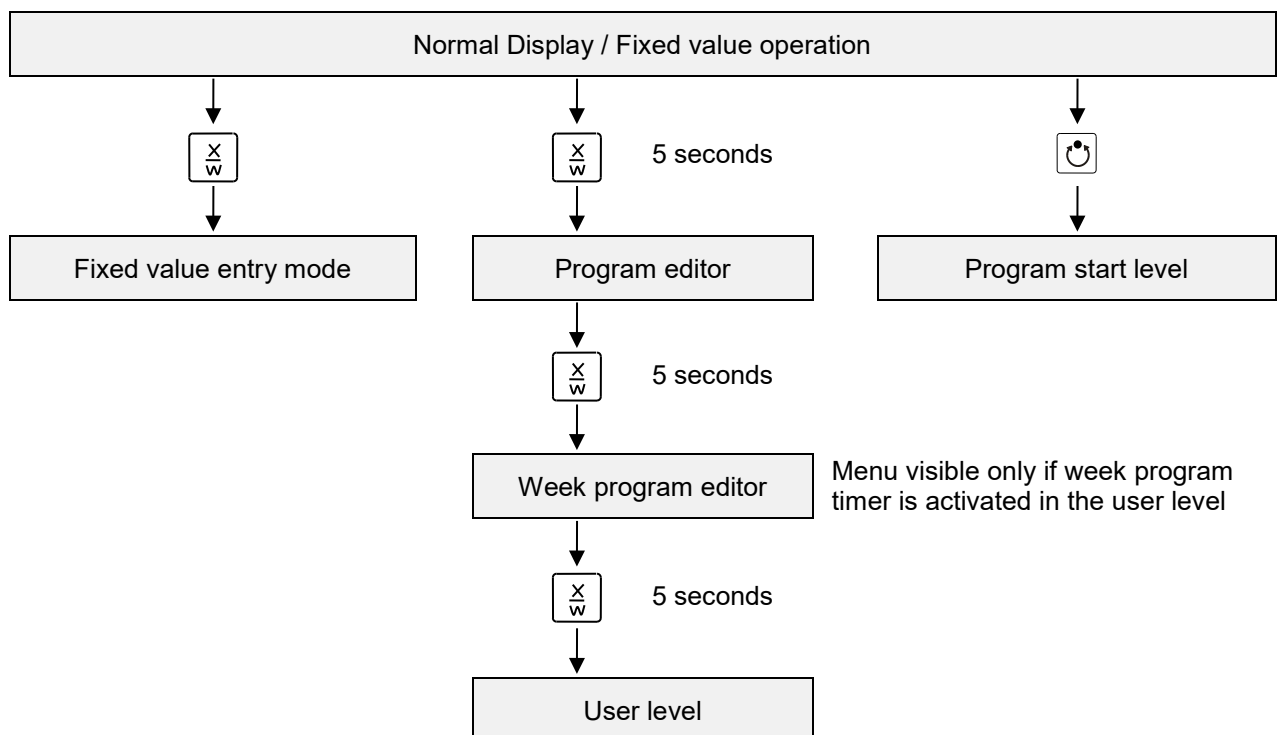

If no button is touched within more than 120 sec. the controller returns from the current level to Normal Display.

6. Fixed value entry mode



If you do not want to use the week program timer, deactivate it (factory setting, setting in the user level, chap. 10) before entering any set-points.



The regular door gasket made of FKM is only temperature resistant up to max. 200 °C. For temperatures above 200 °C please use the optional door gasket made of high temperature resistant silicon.

Basic entry principle: Access the individual parameters with button X/W one after the other. Enter the values with the arrow keys. A value flashing once after 2 seconds indicates that it has been applied by the controller.

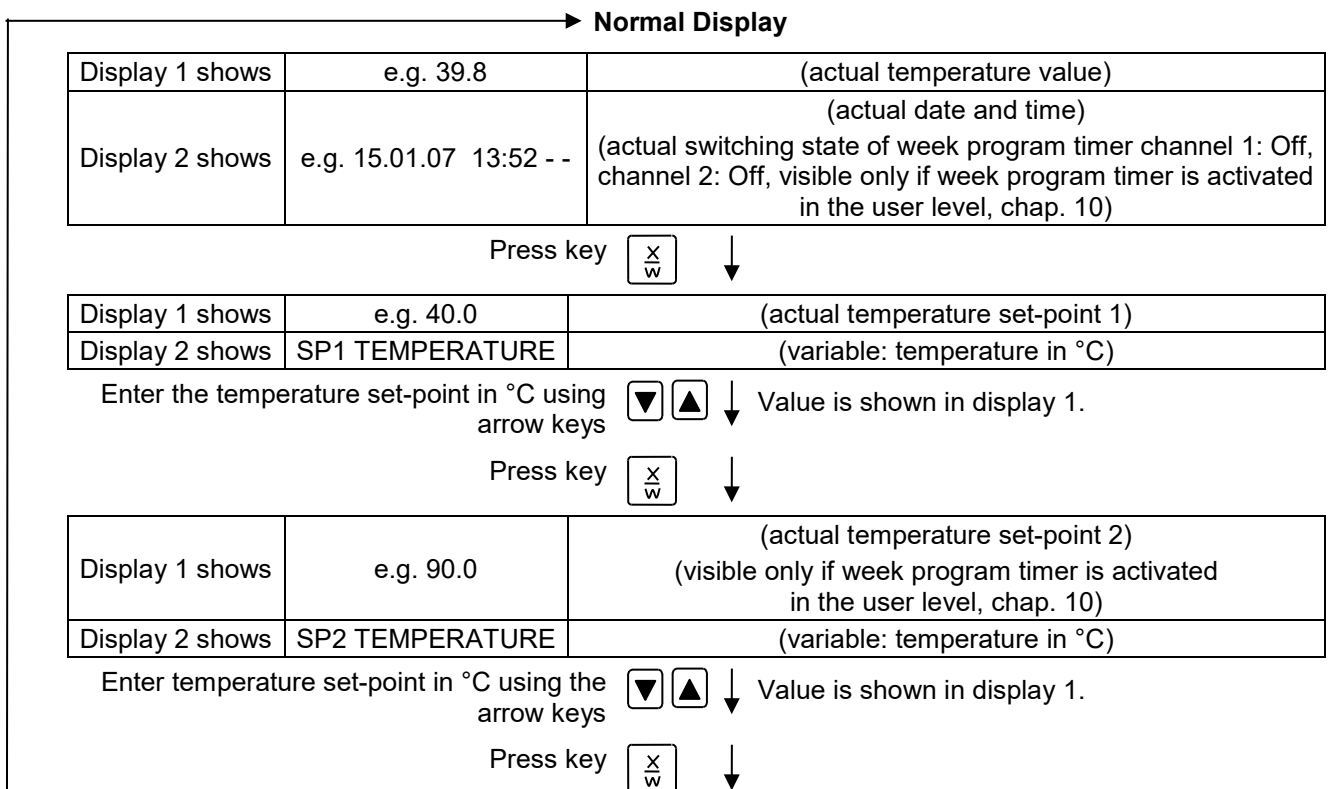

If no button is pressed within more than 120 sec, or if the EXIT button is pressed, the controller changes to Normal Display.



When changing the set-point, check the setting of the temperature safety device (chap. 12.1).



The values entered in fixed-value entry mode remain valid after program run-off and are then equilibrated.

If the week program timer is active, depending on the running week program another set-point (SP2) may be targeted. Temperatures too high for the introduced solvent quantity can occur. Deactivate the week program timer if you do not use it (default setting, setting in the User level, chap. 10).



DANGER

Danger of explosion due to exceeding the maximum permissible drying temperature. Serious injury or death from burns and / or explosion pressure.

➤ Deactivate the week program timer if you do not use it.

7. Week program editor

The Week program editor permits defining up to 4 shift point for each week day. A shift point defines a moment and the switching state ON or OFF of the channels that become active in this instance.

Channel function:

- Channel 1 On = Set-point 2 is equilibrated.
- Channel 1 Off = Set-point 1 is equilibrated
- Channel 2 = reserve



The week program timer is initially set to inactive (factory setting). Therefore, you need to activate the week program timer in the user level (chap. 10).

Normal Display

Display 1 shows	e.g. 39.8	(actual temperature value)
Display 2 shows	e.g. 15.01.07 13:52 - -	(actual date and time, actual state of week program timer channel 1: Off, channel 2: Off)

Press down key  ↓ for 5 sec



Display 1 shows	e.g. 0000	
Display 2 shows	PROGRAM EDITOR	(you are in the program editor)

Press down key  ↓ for 5 sec

Display 1 shows	0000	Menu visible only if week program timer is activated in the user level (chap. 10)
Display 2 shows	WEEK PROG. EDITOR	(you are in the week program editor)

Press program key  ↓

Display 1 shows	0000	
Display 2 shows	UserCod? 0000	(enter user code, display flashes)

Enter the user code using arrow keys   ↓ e.g. **0001** (basic setting, adjustable in the user level, chap. 10).
Value is shown in both displays.

Automatically forward after 2 sec

Display 1 shows	0000	
Display 2 shows	Monday	(selection of day of the week) (actual selection: Monday)

Select the day of the week (Monday up to Sunday) with key  ↓ Day of the week is shown in display 2.

Press program key  ↓

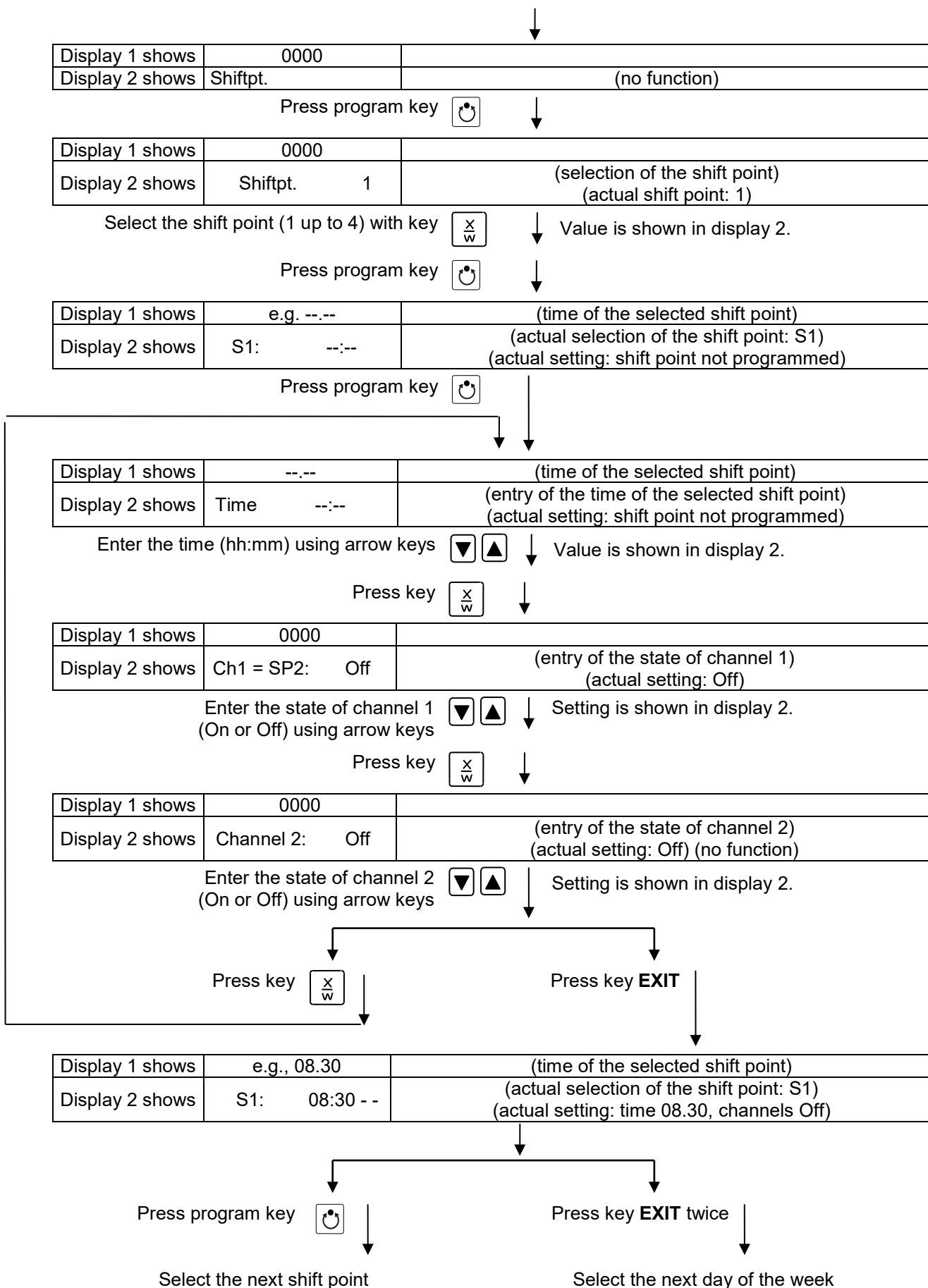

To exit the menu, press several times key **EXIT** or wait for 120 seconds. Controller returns to normal display.

7.1 Program table template for Week program Editor

Program editor	
Program title	
Project	
Date:	

Day of the week	Time			Channel 1 (temperature)	Channel 2*
	hh:mm	AM	PM	ON = SP2 OFF = SP1	ON OFF
Monday	S1				
	S2				
	S3				
	S4				
Tuesday	S1				
	S2				
	S3				
	S4				
Wednesday	S1				
	S2				
	S3				
	S4				
Thursday	S1				
	S2				
	S3				
	S4				
Friday	S1				
	S2				
	S3				
	S4				
Saturday	S1				
	S2				
	S3				
	S4				
Sunday	S1				
	S2				
	S3				
	S4				

* Channel 2 is non-functional in the standard chamber

8. Program editor

8.1 Selecting between set-point ramp and set-point step

You can program various kinds of temperature transitions. In the user level (chap. 10) you can select between the settings “Ramp” (default setting) and “Step”.



Setting “Ramp” permits programming all kinds of temperature transitions. With setting “Step” the controller will equilibrate only to constant temperatures; programming ramps is no longer possible.



Switching between settings “Ramp” and “Step” will influence all programs. Please note that this can cause the time courses of existing programs to change significantly.

8.1.1 Programming with setting “Ramp” (default setting)

Set-points always refer to the start of a program section, i.e., at the beginning of each program section, the entered set-point will be reached. During program section operation, the temperature gradually passes to the set-point entered for the subsequent program section.

You can program all kinds of temperature transitions by the appropriate design of the program section timing:

- **Gradual temperature changes “set-point ramp”**

The set-point gradually moves from one set-point to the one of the following program sections during a given interval. The actual temperature value (X) follows the continually moving set-point (W) at any time.

- **Program sections with constant temperature**

The initial values of two subsequent program sections are identical; therefore, the temperature is kept constant during the whole time of the first program section.

- **Sudden temperature changes “set-point step”**

Steps are temperature changes (ramps) that occur during a very short interval. Two program sections with an identical set-point are followed by a section with a different set-point. If the duration of this transitional program section is very short (minimum entry 1 min), the temperature change will proceed rapidly in the minimum amount of time.

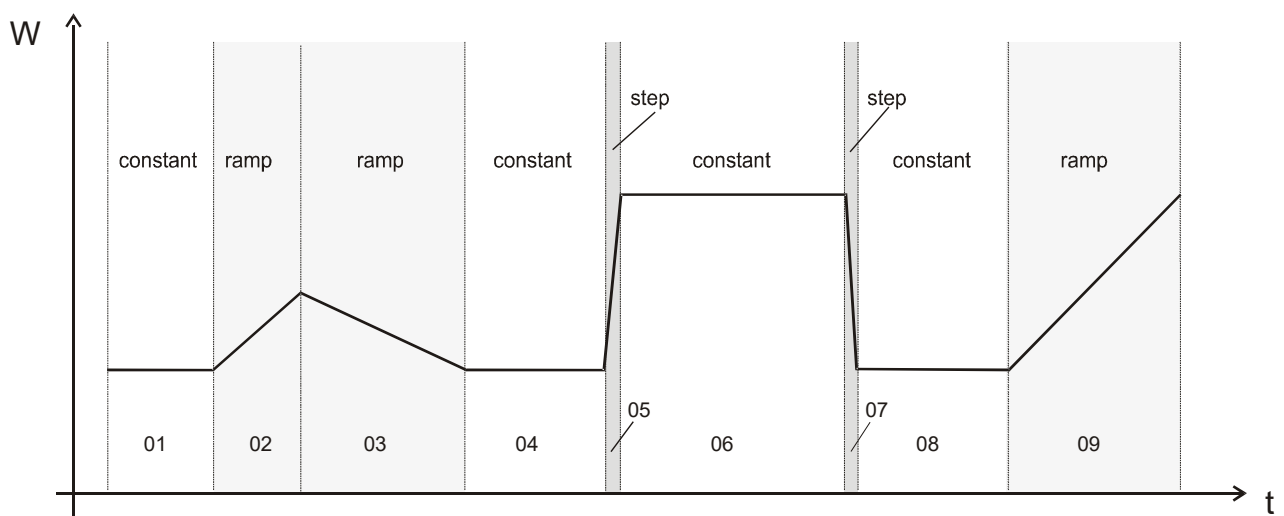
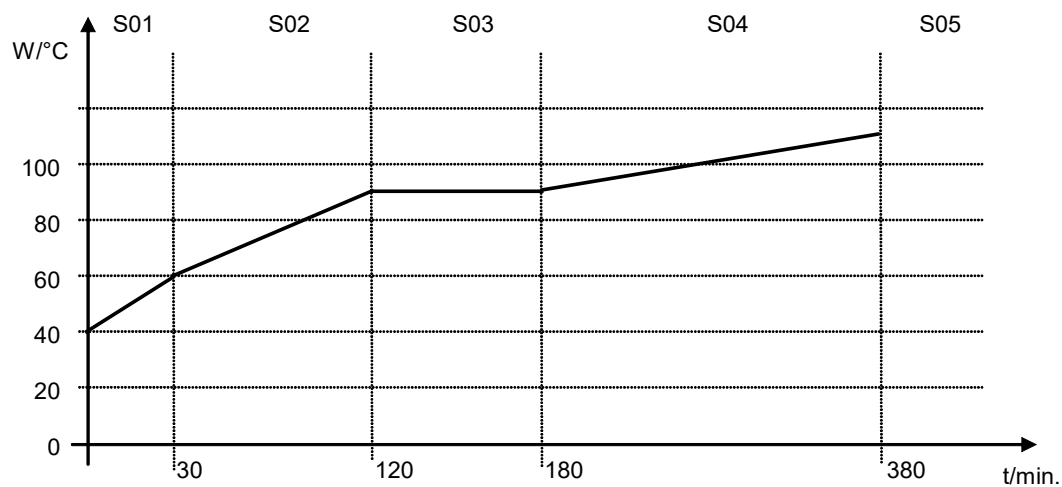

Figure 7: Possible temperature transitions (with default setting “Ramp” in the user level (chap. 10))

Program entry as set-point ramp (example):



Program table corresponding to the diagram (with default setting "Ramp"):

Section	Temperature set-point [°C]	Section length [hh.mm]
SEC	TEMP	TIME
S01	40	00:30
S02	60	01:30
S03	90	01:00
S04	90	03:20
S05	110	00:01

The values of such a program table can now be entered to the RD3 program controller (chap. 8.2).

Program entry as set-point step (example):

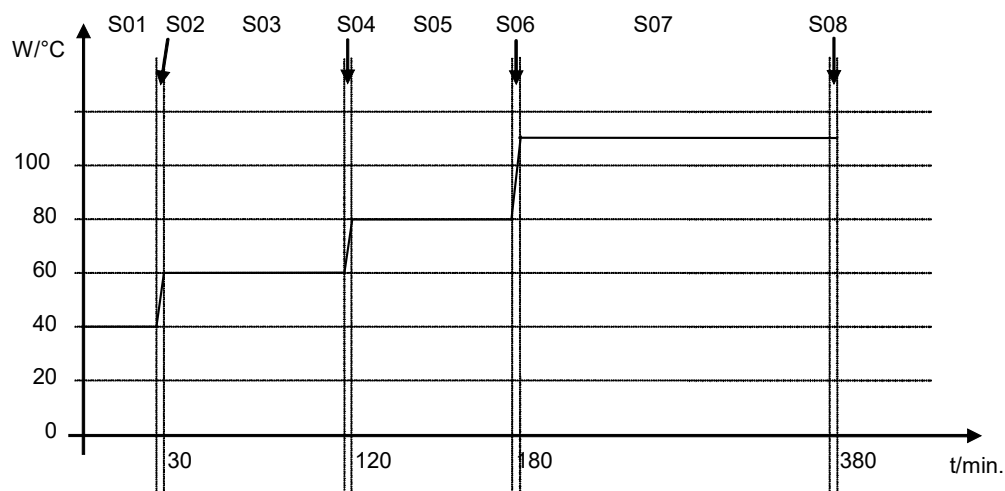

Program table corresponding to the diagram (with default setting “Ramp”):

Section	Temperature set-point [°C]	Section length [hh.mm]
SEC	TEMP	TIME
S01	40	00:30
S02	40	00:01
S03	60	01:30
S04	60	00:01
S05	80	01:00
S06	80	00:01
S07	110	03:20
S08	110	00:01

The values of such a program table can now be entered to the RD3 program controller (chap. 8.2).

The end point of the desired cycle must be programmed with an additional section (in our examples S05 for set-point ramp and S08 for set-point step) with a section time of at least one minute. Otherwise, the program will stop one section too early because the program line is incomplete.

8.1.2 Programming with setting “step”

With setting “Step” selected, you don’t need to program the transition section in the Program Editor.



With setting “step” the controller will equilibrate only to constant temperatures; programming ramps is no longer possible.

The set-points are maintained constant for the duration of a program section. At the start of each program section, the chamber heats up with the maximum speed in order to attain the entered set-point.

Program entry as set-point step (example):

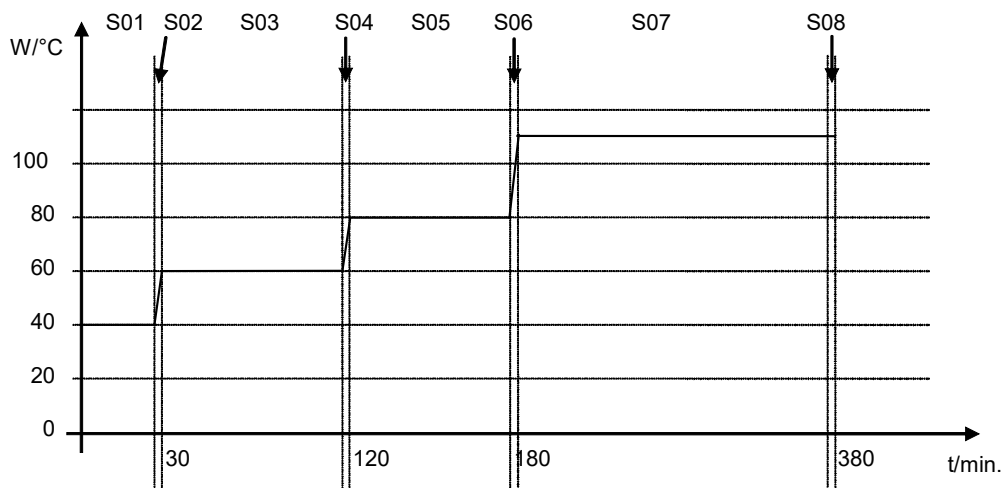

Program table corresponding to the diagram (with setting “Step”):

Section	Temperature set-point [°C] TEMP	Section length [hh.mm] TIME
SEC		
S01	40	00:30
S02	60	01:30
S03	80	01:00
S04	110	03:20

The values of such a program table can now be entered to the RD3 program controller (chap. 8.2).

8.1.3 General notes on programming temperature transitions

If the tolerance limits set in the user level (chap. 10) are exceeded, the program is halted until the actual temperature value returns to within the tolerance range. During this program interruption, the LED (3d) flashes. Therefore, the duration of the program might be extended due to the programming of tolerances

The programming is saved even in case of a power failure or after turning off the chamber.

After program rundown the controller returns to fixed value operation showing Normal Display and equilibrates to the temperature value previously entered in fixed value entry mode.



Before starting the program, check the set-point value entered in fixed value entry mode. After program rundown temperature will equilibrate to this value.



Deactivate the week program timer (factory setting, setting in the user level, chap. 10) before starting a program.



The regular door gasket made of FKM is only temperature resistant up to max. 200 °C. For temperatures above 200 °C please use the optional door gasket made of high temperature resistant silicon.

8.2 Set-point entry for program operation

From Normal Display, press down button X/W for 5 sec to access the program editor. Then enter the set-points one after the other in all program sections of a selected program.

You can enter two programs with up to 10 sections each or one program with up to 20 sections (setting in the user level, chap. 10).

In order to avoid incorrect programming, we recommend entering the values of the program course into a table (template in chap. 8.3).

Example of program table (with default setting “Ramp”):

Section	Temperature set-point [°C] TEMP	Section length [hh.mm] TIME
SEC		
S01	40	00:30
S02	60	01:30
S03	90	01:00
S04	90	03:20
S05	110	00:01

The values of the program table can now be entered to the RD3 program controller.

Step 1 – Selecting the program and the program section:

Normal Display



Display 1 shows	e.g. 39.8	(actual temperature value)
Display 2 shows	e.g. 15.01.07 13:52 - -	(actual date and time, actual state of week program timer channel 1: Off, channel 2: Off)

Press down key  ↓ for 5 sec.

Display 1 shows	e.g. 0000	
Display 2 shows	PROGRAM EDITOR	(you are in the program editor)

Press program key  ↓

Display 1 shows	0000	
Display 2 shows	UserCod? 0000	(enter user code)

Enter user code using arrow keys   ↓ e.g. **0001**
(basic setting, adjustable in the user level,
chap. 10).
Value is shown in both displays.

Automatically forward after 2 sec.

Display 1 shows	e.g. 01	(program P01 selected)
Display 2 shows	--- : --- PRG.	(program can be selected)
alternating	CONTINUE X/W	(information: to 1 st program section with X/W)

Select program P01 or P02 using arrow keys   ↓ Value is shown in display 1.



Press key  ↓

In the selected program P01 or P02, program sections can be selected:

Display 1 shows	e.g. 01	(section S01 selected)
Display 2 shows	P01: --- SEC.	section S01 has already been created. enter new set-points for the individual variables with button X/W
alternating	CONTINUE X/W	

or:

Display 1 shows	e.g. 01	(section S01 selected)
Display 2 shows	P01: --- SEC.	section S01 has not yet been created. enter set-points for the individual variables with button X/W
alternating	NEW SEC. X/W	

Select sections S01 to S10 or to S20 using   ↓
arrow keys

As long as no program section has been entered, the display switches back to 01 in case of any entry > 01, because all sections need to be entered one after the other, and each new section is created as NEWSEC.

Example: If three programs sections have been already entered, the next section to be entered is S04. Before this, no section > S04 can be selected.







Next step – set-point entry in the desired program sections:

Basic entry principle: Access the parameters of individual program sections with button X/W one after the other. Enter the values of the individual parameters with the arrow keys. A value flashing once after 2 seconds indicates that it has been adopted by the controller. If several parameters are to be skipped (e.g. in order to change a parameter in a posterior program section), the parameters can be rapidly jumped over by holding down the X/W key. If no button is pressed for more than 120 sec the controller switches back to Normal Display. The program entered to this point remains stored.

Press key  ↓

Display 1 shows	e.g. 40.0 ^{°C}	(actual temperature set-point)
Display 2 shows alternating	S01: TEMP 40.0	(variable: temperature in °C)
	CONTINUE X/W	(information: go on with X/W)

Enter temperature set-point of S01 in °C using arrow keys   ↓

Press key  ↓

Display 1 shows	e.g. 00.30	(actual section length set-point)
Display 2 shows alternating	S01: TIME 00:30	(variable: section length in hh:mm)
	CONTINUE X/W	(information: go on with X/W)

Enter section length set-point of S01 in hh.mm using arrow keys   ↓ Value is shown in both displays.



Press key  ↓

Selecting the next program sections to be entered



Display 1 shows	e.g. 02	(section S02 selected)
Display 2 shows alternating	P01: --- SEC.	Section S02 has already been created. enter new set-points for the individual parameters with X/W.
	CONTINUE X/W	

or:

Display 1 shows	e.g. 02	(section S02 selected)
Display 2 shows alternating	P01: --- SEC.	Section S02 has not yet been created. enter set-points for the individual parameters with X/W
	NEW SEC. X/W	

Select the next section to be entered using arrow keys   ↓

Display 1 shows	e.g. 60.0 ^{°C}	(actual temperature set-point)
Display 2 shows alternating	S02:TEMP 60.0	(variable: temperature in °C)
	CONTINUE X/W	(information: go on with X/W)

Enter the temperature set-point of S02 in °C using arrow keys   ↓

Etc.

If all sections up to S10 or up to S20 have been programmed, section S01 follows again. In order to quit the entry mode, press the "EXIT" button several times or wait 120 sec → the controller will then return to Normal Display.



When changing the set-point, check the setting of the safety device (chap. 12.1).

8.3 Program table template

Program editor	
Program title	
Project	
Program No.	
Date:	

Section	Temperature set-point [°C]	Section length [hh.mm]
SEC	TEMP	TIME
S01		
S02		
S03		
S04		
S05		
S06		
S07		
S08		
S09		
S10		
S11		
S12		
S13		
S14		
S15		
S16		
S17		
S18		
S19		
S20		

8.4 Deleting a program section

A program section is deleted from the program by setting the section duration to Zero.



Normal display

Press down key  ↓ for 5 sec.

Display 1 shows	e.g. 0000	
Display 2 shows	PROGRAM EDITOR	(you are in the program editor)



Press program key  ↓

Display 1 shows	0000	
Display 2 shows	UserCod? 0000	(enter user code)

Enter the user code using arrow keys   ↓ e.g. **0001**
(basic setting, adjustable in the user level, chap. 10).
Value is shown in both displays.

Automatically forward after 2 sec

Display 1 shows	e.g. 01	(program P01 selected)
Display 2 shows	--- : --- PRG.	(program can be selected)
alternating	CONTINUE X/W	(information: to 1 st program section with X/W)

Select the desired program, e.g. P01, using arrow keys   ↓ Value is shown in display1.

Press key  ↓

In the selected program P01 or P02, program sections can be selected:

Display 1 shows	e.g. 01	(actual selection of the section: S01)
Display 2 shows	P01: --- SEC.	(program section can be selected)
alternating	CONTINUE X/W	(information: set-point entry with X/W)

Select desired section, e.g. S03, using arrow keys   ↓ (omitted if section S01 shall be deleted).



Press key  ↓

Display 1 shows	e.g. 90.0 ^{°C}	(actual temperature set-point)
Display 2 shows	S03:TEMP 90.0	(variable: temperature)
alternating	CONTINUE X/W	(information: continue with X/W)

No entry ↓

Press key  ↓

Display 1 shows	e.g. 01.00	(actual section length)
Display 2 shows	S03:TIME 01:00	(variable: section length)
alternating	CONTINUE X/W	(information: continue with X/W)

Enter set-point **Zero** for section length in hh:mm of S03 using arrow keys   ↓ Value is shown in display 2 or in both displays (display depends on maximum time setting in the user level chap. 10)

Display 1 shows	e.g. 00.00	(actual section length)
Display 2 shows	S03:TIME 00:00	(variable: section length)
alternating	DELETE SEC. X/W	(information: delete section with X/W)

Press key  ↓

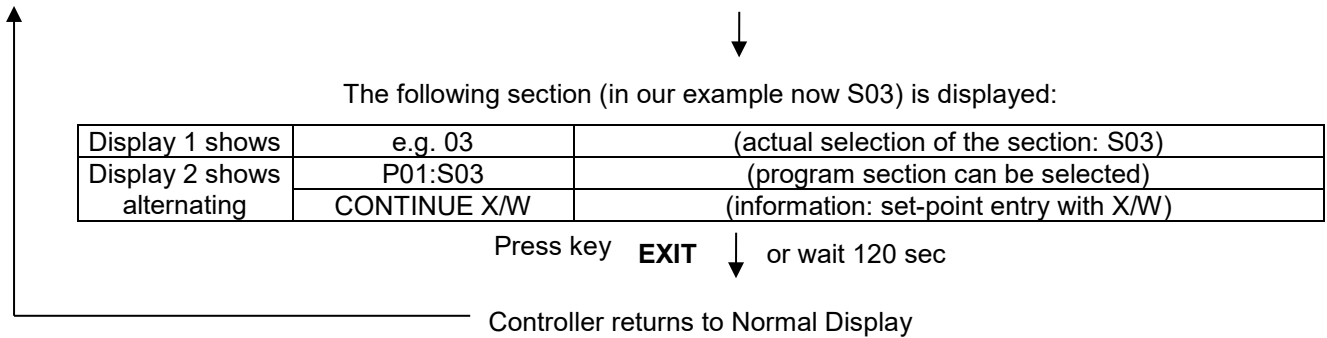



	If you delete a program section which is followed by further sections, those following move up in place of the deleted section.
---	---

In our example, section S03 has been deleted. If sections S04, S05, etc. have been programmed earlier, they will now replace the preceding sections, i.e., S04 is now called S03 etc.



Deletion leads to overwriting the section by the following one. It is therefore not possible to temporarily inactivate a program section. To enter a section later to a program, all the sections following the new one must be entered again.

9. Program start level

Before starting the program, check the set-point entered in Fixed value operation mode. After end of the program, the temperature will equilibrate to this value. This value must not exceed the permitted drying temperature for the used solvent quantity.

	 DANGER
	<p>Danger of explosion due to exceeding the maximum permissible drying temperature after the program ends.</p> <p>Serious injury or death from burns and / or explosion pressure.</p> <ul style="list-style-type: none"> ⊘ Set-point of Fixed value operation must NOT exceed the maximum drying temperature suitable for the solvent quantity. ➤ Check the set-point of Fixed value operation and if necessary adapt it.

After the program ends, the temperature will equilibrate to the set-point entered in Fixed value operation mode. If the week program timer is active, another set-point (SP2) might be targeted according to programming. Temperatures too high for the introduced solvent quantity can occur. Deactivate the week program timer before starting the program (default setting, setting in the User level, chap. 10).

	 DANGER
	<p>Danger of explosion due to exceeding the maximum permissible drying temperature after the program ends.</p> <p>Serious injury or death from burns and / or explosion pressure.</p> <ul style="list-style-type: none"> ➤ Deactivate the week program timer before starting the program.

In the first step, select a program. This is on condition that a program has been entered previously (chap. 8.2) and that program type "2 programs with 10 sections each" has been selected in the user level (chap. 10).

Then define the settings for the program course. Two parameters can be set:

- Program delay time, i.e. a defined time before a program starts. It can be entered with a precision of 1 minute, and its maximum value is 99.59 (99 hs 59 min). If the value is 00.00, the program will start immediately.
- Number of program cycles, i.e. the desired number of program repeats. Values from 1 to 99 can be entered. If the program is not going to be repeated, enter the value "0". For infinite repeats enter the value "-1". The program is repeated as a whole; it is not possible to repeat individual sections.

In the last step start the selected program. These steps must be carried out subsequently.



Deactivate the week program timer (factory setting, setting in the user level, chap. 10) before starting a program.

Step 1 – Program selection (only with program type “2 programs” set):

Normal Display

Press program key  ↓



Display 1 shows	e.g. 1	(actual selection of the program)
Display 2 shows	SEL.PRG.	(select program 1 or 2)

Enter program number 1 or 2 using arrow keys   ↓ Value is shown in display 1.

Next step – entry of program course settings



Press program key  ↓

Display 1 shows	e.g. 00.00	(entered delay time hh.mm)
Display 2 shows	RUN TIME	(enter delay time of program start)

Set delay time in hh.mm using arrow keys   ↓ Value is shown in display 1.

Press program key  ↓

Display 1 shows	e.g. -1	(actual selection of the number of program cycles)
Display 2 shows	REPEAT	(enter number of program cycles)

Select number of cycles -1, 0, 1 etc. using arrow keys   ↓ Value is shown in display 1.

Last step – program start:

Press program key  ↓

Display 1 shows	e.g. 1	(selected program)
Display 2 shows	RUN PRG.	(Question: start selected program?)



Press program key  ↓

Display 1 shows	e.g. 25.5 ^{°C}	actual temperature value
Display 2 shows	P01:S01 00:29:39 (time running backwards)	(actual program P01, actual section S01, and remaining time of program section S01)

Program is running. The green LED (3d) lights up.

In addition to the green LED (3d) indicating a running program, the LED (3a) is lit if the heating is active, or no LED if the actual temperature equals the set-point.

 During program course the arrow keys and the EXIT button are not functional.

 By pressing the program key  for 3 seconds, you can terminate the program course.

If you press button  during program course, the entered set-point of the actually running program section is shown for 5 seconds:

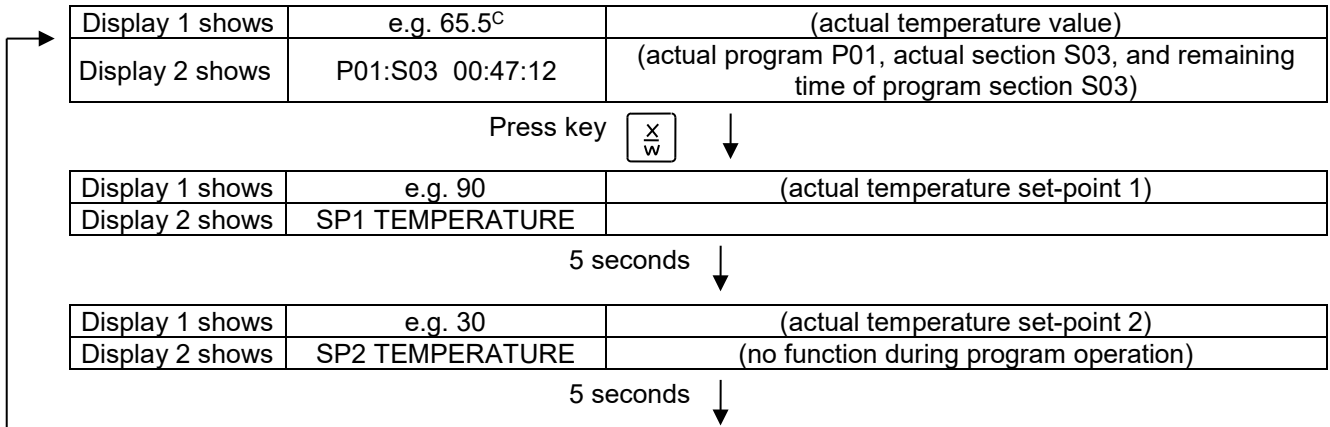

After program runoff (and, if appropriate, of the program repeats) the controller returns to fixed value operation showing Normal Display and adjusting to the temperature value that has been previously entered in the fixed value entry mode.

10. User level

In this menu the following parameters can be set (in brackets the corresponding abbreviated information given in display 2):

- **Chamber address (Address)**
Set the controller address (1 to 255) for operation with the APT-COM™ 4 Multi Management Software.
- **User code (User-cod)**
Modification of the user code setting (factory setting 0001) for access to the user level and the program editor.

 Keep in mind any modification of the user code. There is no access to these levels without a valid user code.

- **Decimal point position (Decimal)**
Selection if integer values or one position after the decimal point can be entered. The integer representation is shown in Display 2 (set-point entry) while the actual value in Display 1 is always shown with one decimal point.
- **Audio Alert (Buzzer)**
Active: in case of an alarm event ((e.g. responding of the safety controller, no heating release, see chap. 11.2) an audible signal (buzzer) will sound. It can be reset by pressing the “EXIT” button.
Inactive: no audible signal (buzzer) in case of an alarm event.

 With a deactivated buzzer there is no acoustical indication the heating is not yet released by the air flow monitoring (e.g. following a power failure)!

- **Selection of controller menu language (Language)**

Select **German**, **English**, or **French**.

- **Counter of operating hours (Oper.hs)**

Information about the number of operating hours currently reached or since the last reset. (no setting, display only).

- **Max. number of operating hours (Op.limit)**

Enter a limit number of operating hours, i.e., the maximum number of operating hours that can be run. Maximum setting: 9999. Reaching the limit has no effect.

- **Reset operating hours (Op.back)**

Reset operating hours to zero.

- **Interface protocol (Protocol)**

“**Modbus**”: The chamber interface can be used as a communication interface to connect it to a computer. This serves to control the chamber by the APT-COM™ 4 Multi Management Software. It is possible to read and write the values of all parameters.

“**Printer**”: A protocol printer for data printouts can be connected to the chamber interface. The printer regularly protocols the actual temperature value with fixed formatting and with adjustable print intervals.

In both cases an interface converter RS 422 / RS 232 is used.

- **Print interval (Prt.-Inv.)**

Set the print interval in minutes. Function is available only if setting “Printer” has been selected in the previous menu point.

- **Display illumination (Disp.LED)**

Select between continuous display illumination and limited illumination, which will automatically go off 300 sec after the last entry.

- **Program type selection (PrgSelec)**

Select between entry of two programs with up to 10 sections each or of one program with up to 20 sections.



When changing from 2 programs to 1 program or vice-versa, existing programs are deleted in the program editor.

- **Maximum section duration (Prg.Time)**

The maximum length of an individual program section can be set to either 99 hs 59 min or to 999 hs 59 min. This setting is then valid for all program sections.



When changing the maximum duration setting, pre-existing programs will be deleted in the program editor.

- **Set-point programming type (Setp.sim)**

Select between “Ramp” and “Step”. With setting “Step” selected, you don’t need to program the transition section in the Program Editor.



If you select setting “Step”, the controller will equilibrate only to constant temperatures; programming ramps becomes impossible.



A change between settings “ramp” and “step” will influence all programs. Note that significant change in time courses may arise in existing programs.

- **Tolerance limit range (Tol.band)**

Entry of a tolerance limit value in °C. If the actual value of temperature exceeds the set-point of a program section by more than the entered tolerance limit value, the program is halted (LED (3d) flashing) until the actual temperature value is again within the tolerance range.

Entry of "0" means tolerance limits are off.

- **Activating or inactivating the week program timer (Prog.Clk)**

"Inactive": The week program timer is turned off (factory setting). The corresponding setting menu (chap. 7) is not visible, nor is set-point 2 in the "Fixed value entry mode" (chap. 6).

"Active": The week program timer is activated.



When deactivating the week program timer, any programming made in advance will remain in memory and take effect when the week program timer is activated again.



Deactivate the week program timer before starting a program (chap. 9).

- **Display mode (12h/24h)**

Select between 12 hours (display "AM" or "PM") or 24 hours.

- **Date of the real time clock (Date)**

Main menu. Use the program key to access the settings of year, month, and day in the corresponding submenus.

- **Year of the real time clock (Year)**

Enter the year (2006 up to 2050)

- **Month of the real time clock (Month)**

Enter the month (1 up to 12).

- **Day of the real time clock (Day)**

Enter the day (1 up to 31).

- **Time of the real time clock (Time)**

Main menu. Use the program key to access the settings of hour and minute in the corresponding submenus.



There is no automatic switch between daylight saving time and regular time.

- **Hour of the real time clock (Hour)**

Enter the hour (0 up to 23).

- **Minute of the real time clock (Minute)**

Enter the minute (0 up to 59).

Normal Display

Display 1 shows	e.g. 19.8	(actual temperature value)
Display 2 shows	e.g. 15.05.06 13:52 - -	(actual date and time, actual switching state of week program timer channel 1: Off, channel 2: Off)

Press down key  ↓ for 5 sec

Display 1 shows	e.g. 0000	
Display 2 shows	PROGRAM EDITOR	(you are in the program editor)

Press down key  ↓ for 5 sec



Display 1 shows	0000	Menu visible only if week program timer is activated.
Display 2 shows	WEEK PROG. EDITOR	(you are in the week program editor)

Press down key  ↓ for 5 sec

Display 1 shows	0000	
Display 2 shows	USER – LEVEL	(you are in the user level)

Press program key  ↓

Display 1 shows	0000	
Display 2 shows	UserCod? 0000	(enter user code, display flashes)

Enter the user code using arrow keys   ↓ e.g. **0001** (basic setting, or the valid code in case it has been previously changed in this menu). Value is shown in both displays.

Automatically forward after 2 sec

Display 1 shows	1	(actual address: 1)
Display 2 shows	Adress 1	(entry of chamber address) (actual address: 1)

Enter the chamber address (1 up to 254) using arrow keys   ↓ Address is shown in both displays.

Press key  ↓

Display 1 shows	1	(actually valid user code: 1)
Display 2 shows	User-cod 1	(change user code) (actually set: 1)

Enter a new value using arrow keys   ↓ Value is shown in both displays.

Press key  ↓

Display 1 shows	0000	(no function)
Display 2 shows	Saf.mode: Limit	(no function)

Press key  ↓

Display 1 shows	0	(no function)
Display 2 shows	Saf.setp 0	(no function)

Press key  ↓

Display 1 shows	0000	(no function)
Display 2 shows	Decimal: XXX.X	(setting of decimal point position) (actual setting: XXX.X)

Select decimal point position using arrow keys   ↓ Decimal point position XXX.X or XXXX. is shown in display 2.

Press key  ↓

Display 1 shows	0000	(no function)
Display 2 shows	Buzzer : Active	(setting of the alarm buzzer) (actual setting: "Active")

Select between "Active" and "Inactiv" using arrow keys   ↓ Setting is shown in display 2.

Press key  ↓

Display 1 shows	0000	(no function)
Display 2 shows	Language: English	(selection of controller language) (actual setting: English)

Select between languages German, English, and French using arrow keys   ↓ Setting is shown in display 2.

Press key  ↓

Display 1 shows	e.g. 0004	(chamber operating hours)
Display 2 shows	Oper.hs 0004:28	(operating hours up to now hhhh:mm) (actually displayed: 4 hs 28 min)

Press key  ↓

Display 1 shows	1000	(actual setting: 1000 hs)
Display 2 shows	Op.limit 1000:00	(maximum number of operating hours hhhh:mm (actual setting: 1000 hs))

Set value using arrow keys   ↓ Setting is shown in both displays.

Press key  ↓

Display 1 shows	0000	(no function)
Display 2 shows	Op.back : No	(reset counter of operating hours ?) (actual setting: No)

Select between "Yes" and "No" using arrow keys   ↓ Setting is shown in display 2.

Press key  ↓

Display 1 shows	0000	(no function)
Display 2 shows	Protocol: MODBUS	(Selection of interface mode) (actual setting: Modbus)

Select between protocols "MODBUS" and "Printer" using arrow keys   ↓ Setting is shown in display 2.



Press key  ↓

Display 1 shows	e.g. 3	(actual setting: 3 min)
Display 2 shows	Prt-Inv. 3	(print interval) (actual setting: 3 min)

Select value between 0 and 255 minutes using arrow keys   ↓ Setting is shown in displays 1 and 2.

Press key  ↓

Display 1 shows	0000	
Display 2 shows	Disp.LED: No	(continuous display illumination?) (actual setting: No)

Select between "Yes" and "No" using arrow keys   ↓ Setting is shown in display 2.



Press key  ↓

Display 1 shows	0000	
Display 2 shows	PrgSelec: 2Prg10S	(1 program with max. 20 sections or 2 programs with max. 10 sections each?) (actual setting: 2Prg10S)

Select between "2Prg10S" and "1Prg20S" using arrow keys   ↓ Setting is shown in display 2.

Press key  ↓

Display 1 shows	0000	
Display 2 shows	Prg.Time: 99:59	(max. section length 99:59 or 999:59?) (actual setting: 99:59)

Select between 99:59 in hh:mm or 999:59 in hhh:mm using arrow keys   ↓ Setting is shown in display 2.

Press key  ↓

Display 1 shows	0000	
Display 2 shows	Setp.sim Ramp	(ramp or step?) (actual setting: ramp)

Select between Ramp and Step using arrow keys   ↓ Setting is shown in display 2.

Press key  ↓

Display 1 shows	0000	
Display 2 shows	Tol.band 0	(Tolerance limits in °C) (actual setting: 0)

Set value in °C using arrow keys   ↓ Setting is shown in display 2.

Press key  ↓

Display 1 shows	0000	
Display 2 shows	Prog.Clk Inactive	(Week program timer active or inactive?) (actual setting: Inactive)

Select between "Active" and "Inactive" using arrow keys   ↓ Setting is shown in display 2.

Press key  ↓

Display 1 shows	0000	
Display 2 shows	12h/24h 24h	(Display mode 12 hours or 24 hours?) (actual setting: 24h)

Select between 12 hours and 24 hours using arrow keys   ↓ Setting is shown in display 2.

Press key  ↓

Display 1 shows	0000	
Display 2 shows	Date	(Main menu: Setting the date of the real time clock)



Press program key  ↓

Display 1 shows	e.g. 2006	(Actual setting: 2006)
Display 2 shows	Year 2006	(Setting the year of the real time clock)

Set year (2006 up to 2050) using arrow keys   ↓ Setting is shown in display 2.

Press key  ↓

Display 1 shows	e.g. 5	(Actual setting: may)
Display 2 shows	Month 5	(Setting the month of the real time clock)

Set month (1 up to 12) using arrow keys   ↓ Setting is shown in display 2.

Press key  ↓

Display 1 shows	e.g. 15	(Actual setting: 15)
Display 2 shows	Day 15	(Setting the day of the real time clock)

Set day (1 up to 31) using arrow keys   ↓ Setting is shown in display 2.

Press key **EXIT** ↓

Press key  ↓

Display 1 shows	0000	
Display 2 shows	Time	(Main menu: Setting the time of the real time clock)



Press program key  ↓

Display 1 shows	e.g. 13	(Actual setting: 13, i.e. 1 p.m.)
Display 2 shows	Hour 13	(Setting the hour of the real time clock)

Set hour (0 up to 23) using arrow keys   ↓ Setting is shown in display 2.

Press key  ↓

Display 1 shows	e.g. 30	(Actual setting: 30 minutes)
Display 2 shows	Minute 30	(Setting the minute of the real time clock)

Set minute (0 up to 59) using arrow keys   ↓ Setting is shown in display 2.

Press several times key **EXIT** ↓ or wait for 120 seconds

Controller returns to normal display.

11. Behavior in case of failures

11.1 Behavior after a power failure

Power failure during fixed-value operation (Normal Display): the entered parameters remain saved. After the power returns, indicator light “AIR” (3) is lit, indicating that the heating has not yet been released by the air flow monitoring. As an additional indication there is an acoustical signal which can be reset on the controller. Press pushbutton “START” (4) to start prepurge. After completing prepurge and release of the heating, operation continues with the set parameters. Now you can reset the visual indication “RESET ALARM” on the controller.

Power failure during program operation: After the power returns, indicator light “AIR” (3) is lit, indicating that the heating has not yet been released by the air flow monitoring. As an additional indication there is an acoustical signal which can be reset on the controller. Program course continues with the set-points that have been reached previously during program operation. Press pushbutton “START” (4) to start prepurge. After completing prepurge and release of the heating, the set-points are equilibrated again. Now you can reset the visual indication “RESET ALARM” on the controller.

11.2 Alarm messages

Alarm messages, e.g. “RANGE ERROR CH1” in case of sensor rupture, are shown in Display 2 only in Normal Display.

The message “RESET ALARM” appears when the heating has not yet been released by the air flow monitoring.

A buzzer can be activated / deactivated in the user level (chap. 10). It can be reset by pressing the EXIT button. The alarm text shown in Normal Display goes off only if the cause of the alarm does not exist any longer.

12. Safety devices

12.1 Temperature safety device class 2

The temperature safety device class 2 (DIN 12880:2007) protects the chamber, its environment and the charging material from exceeding the maximum permissible temperature.

Please observe the regulations applicable to your country (for Germany: DGUV guidelines 213-850 on safe working in laboratories, issued by the employers' liability insurance association).

In the event of a fault in the temperature controller, the safety device (2) **permanently** turns off the chamber. Only the fan continues running for safety reasons. This status is reported visually by the indicator lamp (2a) and acoustically by the buzzer.

The operation of the safety device (2) is checked by moving it slowly counter-clockwise until it is turned off. The safety device cut-off is reported visually by the indicator lamp (2a) and acoustically by the buzzer.

Then release the safety device by pressing the reset button (2b) and turn on the chamber as described previously.

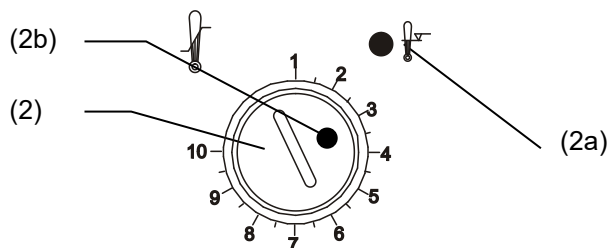

Figure 8: Safety thermostat class 2

Function:

The safety thermostat class 2 is functionally and electrically independent of the temperature control device and turns off the chamber at all poles.



When the control knob (2) is set to the end stop (position 10), the safety thermostat class 2 acts as a chamber protection device. If it is set somewhat higher than the set-point temperature selected on the controller, it acts as a material protection device.

When the safety device has turned off the chamber, identifiable by the red alarm lamp (2a) lighting up, proceed as follows:

- Disconnect the chamber from the power supply.
- Have the cause of the fault examined and rectified by a technician.
- Release safety thermostat class 2 by pressing reset button (2b).
- Restart the chamber as described in chap. 5.

Setting:

The diagram given in chap. 2.3 indicates the drying temperature to be set on the controller in relation to the quantity of the introduced solvents. This must not be exceeded. For this reason, adjust the temperature safety device according to the selected set-point.

	 DANGER
<p>Danger of explosion due to exceeding the maximum permissible drying temperature. Serious injury or death from burns and / or explosion pressure.</p> <p>∅ Do NOT exceed the maximum drying temperature for the solvent quantity.</p>	

To check at which temperature the safety device activates, turn on the oven and set the required nominal value on the temperature controller.

The scale division from 1 to 10 corresponds to the temperature range from 30 °C / 86 °F up to 320 °C / 608 °F and serves as a setting aid.

- Detach the plastic cover over the temperature safety device class 2 (2) with a suitable Phillips screwdriver.
- Turn the control knob (2) of the safety device using a coin to its end-stop (position 10) (chamber protection).
- When the set point is reached, turn back the control knob (2) until its trip point (turn it counter-clockwise) is reached.
- The red alarm lamp (2a) lighting up identifies the trip point; and the reset button (2b) pops out.
- The optimum setting of the safety device is obtained by turning the knob clockwise by approx. one graduation mark on the scale.
- Push the reset button (2b) in again.
- Restore the plastic cover to prevent misadjusting

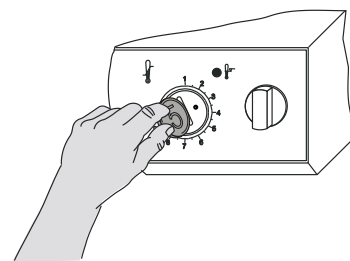



Figure 9: Setting the safety device class 2

	<p>The chamber is only active when the reset button (2b) is pushed in.</p>
---	--

When the safety thermostat class 2 responds, the red alarm lamp (2a) illuminates, the reset button (2b) pops out and the chamber turns off permanently at all poles. Only the fan keeps turning for safety reasons.

	<p>Check the safety thermostat regularly and adjust it following changes of the set-point.</p> <p>Fixed value operation: Adapt the temperature safety device every time the set-point for temperature is changed. Set the set-point of temperature safety device by about 5 °C to 10 °C above the controller temperature set-point.</p> <p>Program operation: Adapt the temperature safety device to the highest temperature set-point value of the program actually used.</p>
---	--

Functional check:

Test the functional capability of the safety thermostat at appropriate intervals. It is recommended having this check performed by the authorized service personnel, e.g. before the beginning of a long working process.

12.2 Exhaust air monitoring

If the volumetric flow rate of the exhaust air is too low, the heating and fan turn off immediately for safety reasons. The indicator light “AIR” (3) lights up. As an additional indication there is an acoustical signal which can be reset on the controller. The visual alarm message “RESET ALARM” on the controller is shown until the next release of the heating.

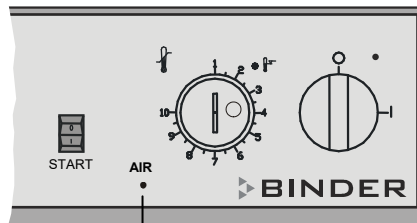

(3) Red indicator light “AIR”: loss of technical ventilation

(3)

Figure 10: Instrument panel (detail)

It is the operator’s responsibility to ensure that the doors of drying ovens are opened immediately on failure of the technical ventilation system (GUV-R 500 chap. 2.28).

	<p>On failure of the technical ventilation, open the door of the safety drying oven.</p>
---	--

13. Options

13.1 APT-COM™ 4 Multi Management Software (option)

The chamber is regularly equipped with a serial interface RS 422 that can connect the BINDER APT-COM™ 4 Multi Management Software. The connection to a computer is established using the FDL interface via an interface converter RS 422 / RS 232.



Confirm that the interface mode is correctly set to “Modbus” in the user level (chap. 10).

The actual temperature values are given at adjustable intervals. Programming can be performed graphically via PC. Up to 100 chambers can be cross linked. For further information, please refer to the APT-COM™ 4 operating manual.

Pin allocation of the RS 422 interface at the rear of the incubator:	Pin 2:	RxD (+)
	Pin 3:	TxD (+)
	Pin 4:	RxD (-)
	Pin 5:	TxD (-)
	Pin 7:	Ground

13.2 Ethernet interface (available via BINDER INDIVIDUAL customized solutions)

With this option, the chamber is equipped with an Ethernet interface that can connect the BINDER APT-COM™ 4 Multi Management Software. The actual temperature values are given at adjustable intervals. Programming can be performed graphically via PC. The MAC Address is indicated below the Ethernet interface. For further information, please refer to the APT-COM™ 4 operating manual.

The additional RS422 interface is only used for service purposes. Do NOT connect it to any network. The interface is labeled accordingly.

13.3 Coil-coating door flap (option)

The coil-coating flap serves to avoid the chamber cooling down while loading the drying oven. With this option, the desired temperature is given from the beginning of the test period. The setting up process with this option is the same as described in chap. 5.

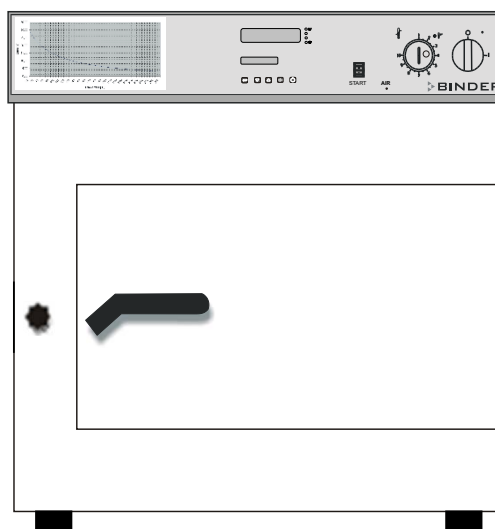

Figure 11: Front view FDL with coil coating door flap (option)







With the option coil-coating you can put in the test sheet only via the flap. The chamber may only be used for simulation of coil coating applications.

14. Cleaning and decontamination

Clean the chamber after each use in order to prevent potential corrosion damage by ingredients of the loading material.

Prior to renewed startup, allow the chamber to completely dry after all cleaning and decontamination measures.

  	 DANGER
	<p>Electrical hazard by water entering the chamber.</p> <p>Deadly electric shock.</p>
	<ul style="list-style-type: none"> ⊘ Do NOT spill water or cleaning agents over the inner and outer chamber surfaces. ⊘ Do NOT put ANY cleaning aids (cloth or brush) into slots or openings on the chamber.
	<ul style="list-style-type: none"> ➤ Before cleaning, turn off the chamber at the main power switch and disconnect the power plug. Let the chamber cool down to ambient temperature. ➤ Completely dry the chamber before turning it on again.

14.1 Cleaning

Disconnect the chamber from the power supply before cleaning. Disconnect the power plug.

	<p>Always keep clean the inner parts of the safety drying oven including the drip pans, drip trays and exhaust-air ducts. Remove the remnants of coating material at suitable intervals.</p>
---	--

Wipe the surfaces with a moistened towel. In addition, you can use the following cleaning agents:

<p>Exterior surfaces inner chamber racks door gaskets</p>	<p>Standard commercial cleaning detergents free from acid or halides. Alcohol based solutions. We recommend using the neutral cleaning agent Art. No. 1002-0016.</p>
<p>Instrument panel</p>	<p>Standard commercial cleaning detergents free from acid or halides. We recommend using the neutral cleaning agent Art. No. 1002-0016.</p>
<p>Zinc coated hinge parts rear chamber wall</p>	<p>Standard commercial cleaning detergents free from acid or halides. Do NOT use a neutral cleaning agent on zinc coated surfaces.</p>

Do not use cleaning agents that may cause a hazard due to reaction with components of the device or the charging material. If there is doubt regarding the suitability of cleaning products, please contact BINDER service.

	<p>We recommend using the neutral cleaning agent Art. No.1002-0016 for a thorough cleaning.</p> <p>Any corrosive damage that may arise following use of other cleaning agents is excluded from liability by BINDER GmbH.</p> <p>Any corrosive damage caused by a lack of cleaning, is excluded from liability by BINDER GmbH.</p>
---	---

	NOTICE
	<p>Danger of corrosion by using unsuitable cleaners. Damage to the chamber.</p> <ul style="list-style-type: none"> ∅ Do NOT use acidic or chlorine cleaning detergents. ∅ Do NOT use a neutral cleaning agent on other kind of surfaces e.g., the zinc coated hinge parts or the rear chamber wall.

	<p>For surface protection, perform cleaning as quickly as possible. After cleaning completely, remove any cleaning agents from the surfaces with a moistened towel. Let the chamber dry.</p>
---	---







	<p>Soapsuds may contain chlorides and must therefore NOT be used for cleaning.</p>
---	--

	<p>With every cleaning method, always use adequate personal safety controls.</p>
---	--

Following cleaning, leave the chamber door open or remove the access port plugs.

	<p>The neutral cleaning agent may cause health problems in contact with skin and if ingested. Follow the operating instructions and safety hints labeled on the bottle of the neutral cleaning agent.</p>
--	---

Recommended precautions: To protect the eyes use sealed protective goggles. Wear gloves. Suitable protective gloves in full contact with media: butyl or nitrile rubber, penetration time >480 minutes.

 	 CAUTION
 	<p>Danger of chemical burns through contact with skin or ingestion of the neutral cleaning agent.</p> <p>Skin and eye damage. Environmental damage.</p> <ul style="list-style-type: none"> ∅ Do not ingest the neutral cleaning agent. Keep it away from food and beverages. ∅ Do NOT empty the neutral cleaning agent into drains. ➤ Wear protective gloves and goggles. ➤ Avoid skin contact with the neutral cleaning agent.
	

14.2 Decontamination / chemical disinfection

The operator must ensure that proper decontamination is performed in case a contamination of the chamber by hazardous substances has occurred.

Disconnect the chamber from the power supply prior to chemical decontamination. Pull the power plug.

Do not use decontamination agents that may cause a hazard due to reaction with components of the device or the charging material. If there is doubt regarding the suitability of cleaning products, please contact BINDER service.

You can use the following disinfectants:

Inner chamber	Standard commercial surface disinfectants free from acid or halides. Alcohol based solutions. We recommend using the disinfectant spray Art. No. 1002-0022.
---------------	---

	For chemical disinfection, we recommend using the disinfectant spray Art. No. 1002-0022. Any corrosive damage that may arise following use of other disinfectants is excluded from liability by BINDER GmbH.
---	---



	With every decontamination method, always use adequate personal safety controls.
---	--

In case of contamination of the interior by biologically or chemically hazardous goods, there are three possible procedures depending on the type of contamination and charging material.

- (1) The safety drying ovens FDL can be hot air sterilized at 190 °C / 374°F for at least 30 minutes. All inflammable goods must be removed from the interior before.
- (2) Spray the inner chamber with an appropriate disinfectant.
Before start-up, the chamber must be absolutely dry and ventilated, as explosive gases may form during the decontamination process.
- (3) If necessary, remove strongly contaminated inner chamber parts for cleaning. Sterilize them in a sterilizer or autoclave.

	In case of eye contact, the disinfectant spray may cause eye damage due to chemical burns. Follow the operating instructions and safety hints labeled on the bottle of the disinfectant spray.
---	--

Recommended precautions: To protect the eyes use sealed protective goggles.

	<div style="background-color: yellow; text-align: center; padding: 5px;"> CAUTION</div> <p>Danger of chemical burns through eye contact with the disinfectant spray.</p> <p>Eye damage. Environmental damage</p> <ul style="list-style-type: none"> ⊘ Do NOT empty the disinfectant into drains. ➤ Wear protective goggles.
---	---

	After using the disinfectant spray, allow the chamber to dry thoroughly, and aerate it sufficiently.
---	--

15. Maintenance and service, troubleshooting, repair, testing

15.1 General information, personnel qualification

- **Maintenance**

See chap. 15.2

- **Simple troubleshooting**

Chap. 15.4 describes troubleshooting by operating personnel. It does not require technical intervention into the chamber, nor disassembly of chamber parts.

For personnel requirements please refer to chap. 1.1.

- **Detailed troubleshooting**

If errors cannot be identified with simple troubleshooting, further troubleshooting must be performed by BINDER Service or by BINDER qualified service partners or technicians, in accordance with the description in the Service Manual.

For personnel requirements please refer to the Service Manual.

- **Repair**

Repair of the chamber can be performed by BINDER Service or by BINDER qualified service partners or technicians, in accordance with the description in the Service Manual.



After maintenance, the chamber must be tested prior to resuming operation.

- **Electrical testing**

To prevent the risk of electrical shock from the electrical equipment of the chamber, an annual repeat inspection as well as a test prior to initial startup and prior to resuming operation after maintenance or repair, are required. This test must meet the requirements of the competent public authorities. We recommend testing under DIN VDE 0701-0702:2008 in accordance with the details in the Service Manual.

For personnel requirements please refer to the Service Manual.

15.2 Maintenance intervals, service

 	 DANGER
	<p>Electrical hazard during live maintenance work.</p> <p>Deadly electric shock.</p> <ul style="list-style-type: none"> ∅ The chamber must NOT become wet during operation or maintenance works. ∅ Do NOT remove the rear panel of the chamber. ➤ Disconnect the chamber before conducting maintenance work. Turn off the main power switch and pull the power plug. ➤ Ensure all maintenance work is conducted by licensed electricians or experts authorized by BINDER.

Ensure regular maintenance work is performed at least once a year.

	The warranty becomes void if maintenance work is conducted by non-authorized personnel.
---	---

It is particularly important to test the function of the flow monitor once a year.

	Record the results of the maintenance tests in a service log
---	--



Replace the door gasket only when cold. Otherwise, the door gasket may become damaged.

We recommend taking out a maintenance agreement. Please consult BINDER Service.

BINDER telephone hotline:	+49 (0) 7462 2005 555
BINDER fax hotline:	+49 (0) 7462 2005 93555
BINDER e-mail hotline:	customerservice@binder-world.com
BINDER service hotline USA:	+1 866 885 9794 or +1 631 224 4340 x3 (toll-free in the USA)
BINDER service hotline Asia Pacific:	+852 390 705 04 or +852 390 705 03
BINDER service hotline Russia and CIS:	+7 495 988 15 16
BINDER Internet website:	http://www.binder-world.com
BINDER address:	BINDER GmbH, post office box 102, D-78502 Tuttlingen

International customers, please contact your local BINDER distributor.

15.3 Cleaning and replacing the intake filter

The fresh air intake filter (fine particle filter for particles 1 µm up to 10 µm, class M6 acc. to EN ISO 16890:2016) at the top right-hand side must be cleaned or replaced from time to time, depending on the degree of soiling. Pull out the slide and blow through the filter cartridge from the inside with compressed air or replace it.

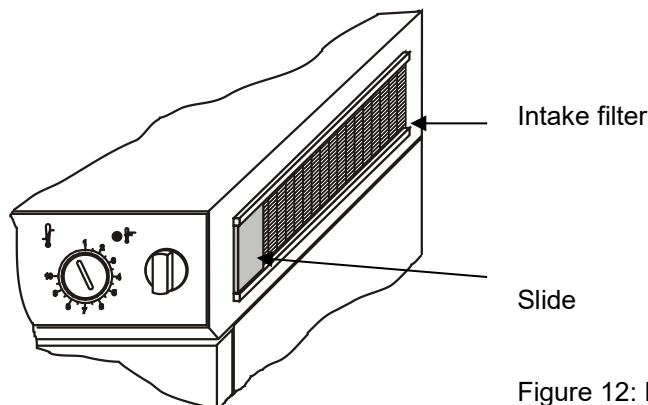

Figure 12: Fresh air intake filter

15.4 Simple troubleshooting

Defects and shortcomings can compromise the operational safety of the chamber and can lead to risks and damage to equipment and persons. If there is a technical fault or shortcoming, take the chamber out of operation and inform BINDER Service. If you are not sure whether there is a technical fault, proceed according to the following list. If you cannot clearly identify an error or there is a technical fault, please contact BINDER Service.



Only qualified service personnel authorized by BINDER must perform repair. Repaired chambers must comply with the BINDER quality standards.



Every fire and explosion in relation to a lacquer dryer must be reported to the employer's liability insurance association (for Germany).

Fault description	Possible cause	Required measures
General		
Chamber without function.	No power supply.	Check connection to power supply. Check whether the chamber is turned on at the main power switch (1).
	Wrong voltage.	Check power supply for correct voltage (chap. 4.2).
	Chamber fuse has responded.	Contact BINDER service.
	Controller defective.	
Heating		
Set-point temperature is not reached after specified time. LED "AIR" (3) is not lit.	Door gasket defective.	Replace door gasket,
	Controller not adjusted.	Calibrate and adjust controller.
Chamber heating permanently, set-point not maintained.	Controller defective.	Contact BINDER service.
	Pt 100 sensor defective.	
	Semiconductor relay defective	Calibrate and adjust controller.
	Controller not adjusted.	
Chamber doesn't heat up. LED "AIR" (3) is not lit. LED (2a) of safety device is lit. Controller display off. Fan turning.	Safety device has turned off the oven. Limit temperature reached. Safety device class 2 (chap. 12.1) set too low.	Allow the oven to cool down the oven and press the "RESET" button. Check temperature set-point and setting of safety device (chap. 12.1). If appropriate, select suitable limit value.
	Semiconductor relay defective.	Contact BINDER service.
	Controller defective.	
	Safety device defective.	
Deviations from the indicated heating-up times.	Oven fully loaded.	Charge the oven less or consider longer heating-up times.
Chamber doesn't heat up. LED "AIR" (3) is lit. Indication "RESET ALARM" in Display 2. Acoustical signal (can be reset on the controller)	With pushbutton "START" (4) the prepurging time has been started. No heating release yet.	Wait approx. 2 minutes.
	Chamber door not closed.	Close the chamber door completely, press pushbutton "START" (4) and wait approx. 2 minutes.
	Condition following a power failure.	Press pushbutton "START" (4) and wait approx. 2 minutes.
	Fan defective.	Contact BINDER service.
	Exhaust air channel blocked.	Check exhaust air system (customer side).
	Intake opening blocked (soiled filter).	Change or clean filter.
Ventilation		
No volumetric flow rate for fresh air and forced-air circulation. LED "AIR" (3) is lit. Indication "RESET ALARM" in Display 2. Acoustical signal (can be reset on the controller)	Chamber door not closed.	Close the chamber door completely, press pushbutton "START" (4) and wait approx. 2 minutes.
	Condition following a power failure.	Press pushbutton "START" (4) and wait approx. 2 minutes.
	Fan defective.	Contact BINDER service.

Fault description	Possible cause	Required measures
Ventilation (continued)		
No fresh air and/or no exhaust air flow. LED "AIR" (3) is lit. Indication "RESET ALARM" in Display 2. Acoustical signal (can be reset on the controller)	Intake opening blocked (soiled filter).	Change or clean filter. Check exhaust air system (customer side).
	Intake air channel blocked.	Check exhaust air system (customer side).
	Exhaust air channel blocked.	
No pressure differential signal at the pipe ends	The measuring pipe in the exhaust passage blocked.	Contact BINDER service.
Pressure differential not sufficient to switch the pressure switch	Rupture of pressure differential measuring hose.	Contact BINDER service.
Controller		
Program duration longer than programmed.	Inappropriate tolerances have been programmed.	For rapid transition phases, do NOT program tolerance limits in order to permit maximum heating speed.
Program stops one section too early.	Program line is incomplete.	When programming, define the end value of the desired cycle by adding an additional section with a section time of at least one minute (with setting set-point ramp).
Programs have been deleted.	Change from 2 programs to 1 program or vice-versa	When changing, ensure that the programs are no longer needed.
The controller returns to Normal Display from any level.	No button was pressed for more than 120 sec.	Repeat entries, enter the values rapidly.
Message RANGE ERROR CH1 in Normal Display in Display 2	Sensor rupture between sensor and controller	Contact BINDER service.
Ramp temperature transitions are only realized as steps.	Set-point programming type set to "Step" in the User level (chap. 10).	Set the set-point programming type to setting "Ramp" in the User level (chap. 10).

15.5 Sending the chamber back to BINDER GmbH

If you return a BINDER product to us for repair or any other reason, we will only accept the product upon presentation of an **authorization number** (RMA number) that has previously been issued to you. An authorization number will be issued after receiving your complaint either in writing or by telephone **prior** to your sending the BINDER product back to us. The authorization number will be issued following receipt of the information below:

- BINDER product type and serial number
- Date of purchase
- Name and address of the dealer from which you bought the BINDER product
- Exact description of the defect or fault
- Complete address, contact person and availability of that person
- Exact location of the BINDER product in your facility
- A contamination clearance certificate (chap. 20) must be faxed in advance

The authorization number must be applied to the packaging in such a way that it can be easily recognized or be recorded clearly in the delivery documents.



For security reasons we cannot accept a chamber delivery if it does not carry an authorization number.

Return address:

BINDER GmbH
 Abteilung Service
 Gänsäcker 16
 78502 Tuttlingen / Germany

16. Disposal

16.1 Disposal of the transport packing

Packing element	Material	Disposal
Straps to fix packing on pallet	Plastic	Plastic recycling
Wooden transport box (option) with metal screws	Non-wood (compressed match-wood, IPPC standard)	Wood recycling
	Metal	Metal recycling
Pallet with foamed plastic stuffing	Solid wood (IPPC standard)	Wood recycling
	PE foam	Plastic recycling
Shipping box with metal clamps	Cardboard	Paper recycling
	Metal	Metal recycling
Edge protection	Styropor® or PE foam	Plastic recycling
Protection of doors and racks	PE foam	Plastic recycling
Bag for operating manual	PE foil	Plastic recycling
Insulating air cushion foil (packing of optional accessories)	PE foil	Plastic recycling

If recycling is not possible, all packing parts can also be disposed of with normal waste.

16.2 Decommissioning

- Turn off the chamber at the main power switch (1) and disconnect it from the power supply (pull the power plug).



When switching off the main power switch ON / OFF (1), the stored parameters remain saved.

- Temporal decommissioning: See indications for appropriate storage, chap. 3.3.
- Final decommissioning: Dispose of the chamber as described in chap. 16.3 to 16.5.

16.3 Disposal of the chamber in the Federal Republic of Germany

According to Annex I of Directive 2012/19/EU of the European Parliament and of the Council on waste electrical and electronic equipment (WEEE), BINDER devices are classified as “monitoring and control instruments” (category 9) only intended for professional use”. They must not be disposed of at public collecting points.

The chambers bear the symbol for the marking of electrical and electronic equipment manufactured / placed on the market in the EC after 13 August 2005 and be disposed of in separate collection according to Directive 2012/19/EU on waste electrical and electronic equipment (WEEE) and German national law for electrical and electronic equipment (Elektro- und Elektronikgerätegesetz, ElektroG). WEEE marking: crossed-out wheeled bin with solid bar under. A significant part of the materials must be recycled in order to protect the environment.

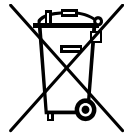

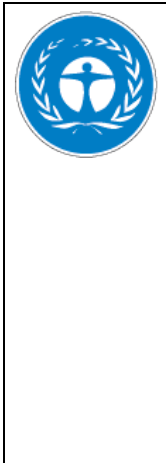

At the end of the device's service life, have the chamber disposed of according to the German national law for electrical and electronic equipment (Elektro- und Elektronikgerätegesetz, ElektroG from 20 October 2015, BGBl. I p. 1739) or contact BINDER service who will organize taking back and disposal of the chamber according to the German national law for electrical and electronic equipment (Elektro- und Elektronikgerätegesetz, ElektroG from 20 October 2015, BGBl. I p. 1739).

	NOTICE
	<p>Danger of violation against existing law if not disposed of properly.</p> <p>Failure to comply with applicable law.</p> <ul style="list-style-type: none"> ∅ Do NOT dispose of BINDER devices at public collecting points. ➤ Have the device disposed of professionally at a recycling company which is certified according to the German national law for electrical and electronic equipment (Elektro- und Elektronikgerätegesetz, ElektroG from 20 October 2015, BGBl. I p. 1739). <li style="text-align: center;"><i>or</i> ➤ Instruct BINDER Service to dispose of the device. The general terms of payment and delivery of BINDER GmbH apply, which were valid at the time of purchasing the chamber.

Certified companies disassemble waste (used) BINDER equipment in primary substances for recycling according to Directive 2012/19/EU. The devices must be free from toxic, infectious or radioactive substances in order to eliminate any health hazards to the employees of the recycling companies.

	<p>Prior to handing the chamber over to a recycling company, it is the user's responsibility that it is free from toxic, infectious or radioactive substances.</p> <ul style="list-style-type: none"> • Prior to disposal clean all introduced or residual toxic substances from the chamber. • Prior to disposal disinfect the chamber from all sources of infection. Be aware that sources of infection may also be located outside the inner chamber. • If you cannot safely remove all toxic substances and sources of infection from the chamber, dispose of it as special waste according to national law. • Fill out the contamination clearance certificate (chap. 20) and enclose it with the chamber.
---	---

 	 WARNING
	<p>Danger of intoxication and infection through contamination of the chamber with toxic, infectious or radioactive substances.</p> <p>Damages to health.</p> <ul style="list-style-type: none"> ∅ NEVER take a chamber contaminated with toxic substances or sources of infection for recycling according to Directive 2012/19/EU. ➤ Prior to disposal, remove all toxic substances and sources of infection from the chamber. ➤ A chamber from which all toxic substances or sources of infection cannot be safely removed must be considered as "special" waste according to national law. Dispose of it accordingly.

As the end user, you are legally obliged to return used batteries. Old batteries and rechargeable batteries must not be disposed of with household waste. They can be handed in free of charge at the community's public collection points and wherever batteries and accumulators of the type in question are sold.

16.4 Disposal of the chamber in the member states of the EU except for the Federal Republic of Germany

According to Annex I of Directive 2012/19/EU of the European Parliament and of the Council on waste electrical and electronic equipment (WEEE), BINDER devices are classified as “monitoring and control instruments” (category 9) only intended for professional use”. They must not be disposed of at public collecting points.

The chambers bear the symbol for the marking of electrical and electronic equipment manufactured / placed on the market in the EC after 13 August 2005 and be disposed of in separate collection according to the Directive 2012/19/EU on waste electrical and electronic equipment (WEEE). WEEE marking: crossed-out wheeled bin with solid bar under.

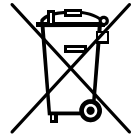





At the end of the device’s service life, notify the distributor who sold you the device, who will take back and dispose of the chamber according to the Directive 2012/19/EU on waste electrical and electronic equipment (WEEE).

	NOTICE
	<p>Danger of violation against existing law if not disposed of properly.</p> <p>Failure to comply with applicable law.</p> <ul style="list-style-type: none"> ⊘ Do NOT dispose of BINDER devices at public collecting points. ➤ Have the device disposed of professionally at a recycling company that is certified according to conversion of the Directive 2012/19/EU into national law. <li style="padding-left: 20px;"><i>or</i> ➤ Instruct the distributor who sold you the device to dispose of it. The agreements apply that were agreed with the distributor when purchasing the chamber (e.g. his general terms of payment and delivery). ➤ If your distributor is not able to take back and dispose of the chamber, please contact BINDER service.



Certified companies disassemble waste (used) BINDER equipment in primary substances for recycling according to Directive 2012/19/EU. The devices must be free from toxic, infectious or radioactive substances in order to eliminate any health hazards to the employees of the recycling companies.

	<p>Prior to handing the chamber over to a recycling company, it is the user’s responsibility that it is free from toxic, infectious or radioactive substances.</p> <ul style="list-style-type: none"> • Prior to disposal, clean all introduced or residual toxic substances from the chamber. • Prior to disposal, disinfect the chamber from all sources of infection. Be aware that sources of infection may also be located outside the inner chamber. • If you cannot safely remove all sources of infection and toxic substances from the chamber, dispose of it as special waste according to national law. • Fill out the contamination clearance certificate (chap. 20) and enclose it with the chamber.
---	---

 	<table border="1"> <tr> <th colspan="2" data-bbox="399 188 1479 259" style="background-color: #f4a460;">  WARNING </th> </tr> <tr> <td colspan="2" data-bbox="399 259 1479 338"> <p>Danger of intoxication and infection through contamination of the chamber with toxic, infectious or radioactive substances.</p> </td> </tr> <tr> <td colspan="2" data-bbox="399 338 1479 394"> <p>Damages to health.</p> </td> </tr> <tr> <td data-bbox="399 394 1479 633"> <ul style="list-style-type: none"> Ø NEVER take a chamber contaminated with toxic substances or sources of infection for recycling according to Directive 2012/19/EU. ➤ Prior to disposal, remove all toxic substances and sources of infection from the chamber. ➤ A chamber from which all toxic substances or sources of infection cannot be safely removed must be considered as “special” waste according to national law. Dispose of it accordingly. </td> <td></td> </tr> </table>	 WARNING		<p>Danger of intoxication and infection through contamination of the chamber with toxic, infectious or radioactive substances.</p>		<p>Damages to health.</p>		<ul style="list-style-type: none"> Ø NEVER take a chamber contaminated with toxic substances or sources of infection for recycling according to Directive 2012/19/EU. ➤ Prior to disposal, remove all toxic substances and sources of infection from the chamber. ➤ A chamber from which all toxic substances or sources of infection cannot be safely removed must be considered as “special” waste according to national law. Dispose of it accordingly. 	
 WARNING									
<p>Danger of intoxication and infection through contamination of the chamber with toxic, infectious or radioactive substances.</p>									
<p>Damages to health.</p>									
<ul style="list-style-type: none"> Ø NEVER take a chamber contaminated with toxic substances or sources of infection for recycling according to Directive 2012/19/EU. ➤ Prior to disposal, remove all toxic substances and sources of infection from the chamber. ➤ A chamber from which all toxic substances or sources of infection cannot be safely removed must be considered as “special” waste according to national law. Dispose of it accordingly. 									

The disposal of batteries within the EU must be carried out in accordance with the current EU directives as well as national, regional and local environmental protection regulations.

16.5 Disposal of the chamber in non-member states of the EU

 	<table border="1"> <tr> <th colspan="2" data-bbox="399 855 1479 913" style="background-color: #00a0e3; color: white;"> NOTICE </th> </tr> <tr> <td colspan="2" data-bbox="399 913 1479 969"> <p>Danger of violation against existing law if not disposed of properly.</p> </td> </tr> <tr> <td colspan="2" data-bbox="399 969 1479 1025"> <p>Failure to comply with applicable law. Alteration of the environment.</p> </td> </tr> <tr> <td data-bbox="399 1025 1479 1142"> <ul style="list-style-type: none"> ➤ For final decommissioning and disposal of the chamber, please contact BINDER service. ➤ Follow the statutory regulations for appropriate, environmentally friendly disposal. </td> <td></td> </tr> </table>	NOTICE		<p>Danger of violation against existing law if not disposed of properly.</p>		<p>Failure to comply with applicable law. Alteration of the environment.</p>		<ul style="list-style-type: none"> ➤ For final decommissioning and disposal of the chamber, please contact BINDER service. ➤ Follow the statutory regulations for appropriate, environmentally friendly disposal. 	
NOTICE									
<p>Danger of violation against existing law if not disposed of properly.</p>									
<p>Failure to comply with applicable law. Alteration of the environment.</p>									
<ul style="list-style-type: none"> ➤ For final decommissioning and disposal of the chamber, please contact BINDER service. ➤ Follow the statutory regulations for appropriate, environmentally friendly disposal. 									

The main board of the safety drying oven includes a lithium cell. Used batteries must be disposed of properly. Please ensure that you dispose of the battery in accordance with the regulations in force in your country.

17. Technical description

17.1 Factory calibration and adjustment

This chamber was calibrated and adjusted in the factory. Calibration and adjustment were performed using standardized test instructions, according to the QM DIN EN ISO 9001 system applied by BINDER (certified since December 1996 by TÜV CERT). All test equipment used is subject to the administration of measurement and test equipment that is also constituent part of the BINDER QM DIN EN ISO 9001 systems. They are controlled and calibrated to a DKD-Standard at regular intervals.

17.2 Definition of usable volume

The usable volume illustrated below is calculated as follows:

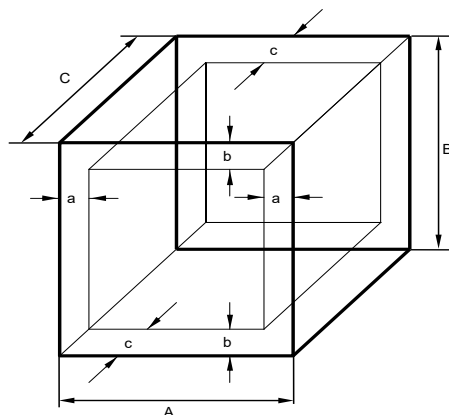

A, B, C = internal dimensions (W, H, D)

a, b, c = wall separation

$$a = 0.1 * A$$

$$b = 0.1 * B$$

$$c = 0.1 * C$$

$$V_{USE} = (A - 2 * a) * (B - 2 * b) * (C - 2 * c)$$

Figure 13: Determination of the usable volume

The technical data refers to the so defined usable volume.



Do NOT place samples outside this usable volume.

Do NOT load this volume by more than half to enable sufficient airflow inside the chamber.

Do NOT divide the usable volume into separate parts with large area samples.

Do NOT place samples too close to each other in order to permit circulation between them and thus obtain a homogenous distribution of temperature and humidity.

17.3 Over current protection

The chamber is equipped with internal fuses not accessible from outside. If these fuses are blown, please inform an electronic engineer or BINDER service.

17.4 FDL 115 technical data

Exterior Dimensions		
Width, net	mm / inch	835 / 32.87
Height gross (including feet)	mm / inch	800 / 31.50
Depth, net	mm / inch	685 / 26.97
Depth gross (including door handle)	mm / inch	735 / 28.94
Wall clearance rear (minimum)	mm / inch	100 / 3.94
Wall clearance side (minimum)	mm / inch	160 / 6.30
Exhaust duct, outer diameter	mm / inch	100 / 3.94
Doors		
Number of doors		1

Interior dimensions			
Width		mm / inch	600 / 23.62
Height		mm / inch	435 / 17.13
Depth		mm / inch	435 / 17.13
Interior volume		l / cu.ft	115 / 4.1
Total steam space volume		l / cu.ft.	156 / 5.51
Racks			
Quantity of racks (regular)			2
Quantity of racks (max.)			5
Maximum load per rack		Kg / lbs	30 / 66
Maximum permitted total load		Kg / lbs	60 / 132
Weight			
Weight of the chamber (empty)		Kg / lbs	88 / 194
Temperature data			
Temperature range, 10 °C above ambient up to		°C / °F	300 / 572
Maximum temperature of the heating surface		°C / °F	750 / 1382
Maximum permitted oven temperature		°C / °F	300 / 572
Temperature fluctuation	at 150 °C / 302 °F	± K	0.8
Temperature uniformity (variation)	at 50 °C / 122 °F	± K	0.5
	at 150 °C / 302 °F	± K	2.5
	at 300 °C / 572 °F	± K	5.8
Heating-up time	to 50 °C / 122 °F	min	15
	to 150 °C / 302 °F	min	20
	to 300 °C / 572 °F	min	60
Temperature data			
Recovery time after door was opened for 30 sec.	to 50 °C / 122 °F	min	8
	to 150 °C / 302 °F	min	12
	to 300 °C / 572 °F	min	20
Ventilation data			
Air circulation		approx. x/min.	20
Air change acc. to EN 1539:2015 at 50 °C		approx. x/min.	2.5
Volumetric flow rate of exhaust air acc. to EN 1539:2015 at 50 °C		approx. l/min	400
		approx. m ³ /h	24.0
Solvent data			
Highest permitted solvent quantity acc. to EN 1539:2015 (at T-180 °C, M-100g/mol, U-40g/m ³ , K=0,5)		g	6.65
Electrical data			
Housing protection acc. to EN 60529		IP	33
Nominal voltage (+5 %)	at 50 Hz power frequency	V	230
	at 60 Hz power frequency	V	230
Current type			1N~
Nominal current		Amp	13.0
Nominal power		kW	2.90
Power plug			grounded plug
Over-voltage category acc. to IEC 61010-1			II
Pollution degree acc. to IEC 61010-1			2
Environment-specific data			
Noise level (mean value)		dB(A)	57
Energy consumption	at 150 °C / 302 °F	Wh/h	1098

Remarks:

Indications on the total steam space volume: If the volume of the drying material inserted in the dryer exceeds 10% of the total steam area, it must be deducted in the calculation of the total steam volume.

Indications on the heating-up and recovery times: Values without considering the prepurge time

Procedure to determine the volumetric flow rate of exhaust air: "Calculation of the volumetric flow rate through the exhaust duct based on the velocity of flow measured there with a propeller anemometer"

Highest permitted solvent quantity: At a drying temperature of 180 degrees Celsius and an average molecular weight of the solvent of M=100g/mole. For a different drying temperature, the highest permissible solvent quantity must be recalculated. The calculation should be made on the basis of the "principles for the calculation of ventilation of chamber dryers and continuous dryers" in accordance with industrial standard EN 1539:2015, Appendix B.

All technical data is specified for unloaded chambers with standard equipment at an ambient temperature of +22 °C ± 3 °C / 71.6 °F ± 5.4 °F and a power supply voltage fluctuation of +/- 5%. Technical data is determined in accordance to BINDER Factory Standard Part 1:2015 following DIN 12880:2007.

All indications are average values, typical for chambers produced in series. We reserve the right to change technical specifications at any time.



If the chamber is fully loaded, the specified heating up times may vary according to the load.

17.5 Equipment and Options (extract)



To operate the safety drying oven, use only original BINDER accessories or accessories / components from third-party suppliers authorized by BINDER. The user is responsible for any risk arising from using unauthorized accessories.

Regular equipment
Electronically controlled APT.line™ heating technology
In compliance with all safety requirements according to EN 1539: 2015, EN ISO 13849-1:2015, and GUV-R 500 Kap. 2.28 „Betreiben von Trocknern für Beschichtungsstoffe“ (“Dryers for coating materials”) (for Germany)
Multifunction program controller RD3 with digital display
Adjustable ramp functions via program editor
Temperature safety controller class 2 acc. to DIN 12880:2007
Communication and printer interface RS 422
Fresh-air monitoring with visual and audible alarms and automatic heating shut-off
Replaceable fresh-air filter cartridge (fine-particle filter for particle sizes 1 µm to 10 µm, class M6 acc. to EN ISO 16890-1:2016)
FKM door gasket (for max. temp. 200 °C / 392°F)
2 chrome-plated racks
Rear exhaust duct, diameter 100 mm / 3.94 inch

Options / accessories
Access ports with various diameters, with silicone plug
Rack, chrome-plated or stainless steel
Perforated rack, stainless steel
Reinforced rack stainless steel, with 1 set rack lockings
Reinforced inner chamber with 2 reinforced racks
Lockable door
Silicone door gasket resistant to high temperatures > 200 °C / 392°F. Attention: Above 250 °C / 482°F the gasket will age faster

Options / accessories
Silicone door gasket resistant to high temperatures > 200 °C / 392°F. Attention: Above 250 °C / 482°F the gasket will age faster
Fresh air replacement filter (class M6 acc. to EN ISO 16890:2016) for particles 1µm to 10µm), with aluminum frame
Measurement of air change rate acc. to ASTM D 5374:2013
Door flap for very quick charging for Coil-Coating/Hot Air Short Cycle
Factory calibration certificate, measurement in the center
Extension of factory calibration certificate (additional value)
Measuring protocol acc. to DIN 12880:2007
Qualification folder
Neutral cleaning agent (liquid concentrate)
Stable table on wheels with castors and locking brakes

17.6 Accessories and spare parts (extract)

	BINDER GmbH is responsible for the safety features of the chamber only, provided skilled electricians or qualified personnel authorized by BINDER perform all maintenance and repair, and if components relating to chamber safety are replaced in the event of failure with original spare parts. The user is responsible for any risks arising from using unauthorized accessories/components.
---	--

Description	Art. No.
Rack, chrome-plated	6004-0003
Rack, stainless steel	6004-0008
Perforated rack, stainless steel	6004-0030
Door gasket made of FKM (temperature resistant up to 200 °C / 392 °F)	6005-0030
Door gasket silicone (high temperature resistant)	8012-0499
Protective cover for thermostat class 2	6002-0077
Pilot lamp, red	5008-0003
Temperature sensor Pt 100 bend-off	5002-0007
Chamber foot, black	6002-0006
Fresh air replacement filter, class M6	6014-0001
Neutral cleaning agent, 1 kg	1002-0016
Stable table on wheels with castors and locking brakes	9051-0018

For information on components not listed here, please contact BINDER Service.

Validation service	
Qualification folder IQ-OQ (printed version)	7007-0001
Qualification folder IQ-OQ (digital version)	7057-0001
Qualification folder IQ-OQ-PQ (printed version)	7007-0005
Qualification folder IQ-OQ-PQ (digital version)	7057-0005
Execution of IQ-OQ	DL400100
Execution of IQ-OQ-PQ	DL440500

Calibration service	
Calibration of temperature including certificate (1 measuring point)	DL300101
Spatial temperature measurement including certificate (9 measuring points)	DL300109
Spatial temperature measurement including certificate (18 measuring points)	DL300118
Spatial temperature measurement including certificate (27 measuring points)	DL300127
Measurement of air ventilation acc. to ASTM D 5374:2013, including certificate	DL330000

17.7 Dimensions FDL 115

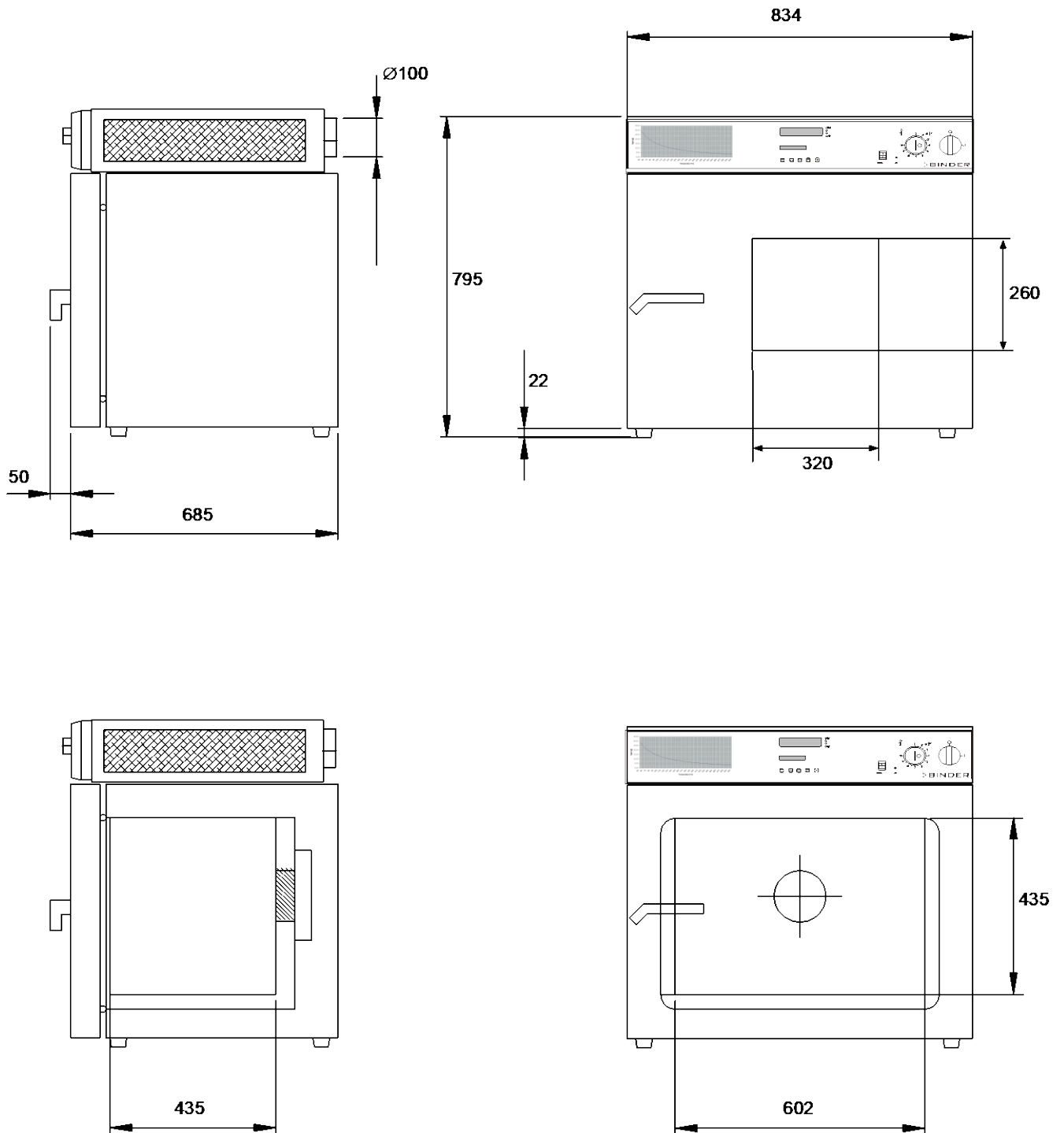

Figure 14: Dimensions FDL 115

18. Certificates and declarations of conformity

18.1 EU Declaration of Conformity

CE EU-Konformitätserklärung / EU Declaration of Conformity / Déclaration de conformité UE / Declaración de conformidad UE / Dichiarazione di conformità UE / Декларация соответствия EU

Hersteller / Manufacturer / Fabricant / Fabricante / Fabbrikante / Производитель	BINDER GmbH
Anschrift / Address / Adresse / Dirección / Indirizzo / Адрес	Im Mittleren Ösch 5, 78532 Tuttlingen, Germany
Produkt / Product / Produit / Producto / Prodotto / Продукт	Sicherheitstrockenschrank Safety drying oven Armoire séchante de sécurité Cámara de secado de seguridad Stufa di essiccazione di sicurezza Безопасные сушильные шкаф
Typenbezeichnung / Type / Type / Tipo / Tipo / Тип	FDL 115
Art. Nr. / Art. no. / N° réf. / N.° art. / Cod. art. / № арт.	9010-0292, 9110-0292

Die oben beschriebenen Maschinen sind konform mit folgenden EG/EU-Richtlinien (gemäß Veröffentlichung im Amtsblatt der europäischen Kommission):

The machines described above are in conformity with the following EC/EU Directives (as published in the Official Journal of the European Union):

Les machines décrites ci-dessus sont conformes aux directives CE/UE suivantes (selon leur publication dans le Journal officiel de l'Union européenne):

La máquina descrita arriba cumple con las siguientes directivas de la CE/UE (publicados en el Diario oficial de la Unión Europea):

Le macchine sopra descritte sono conforme alle seguenti direttive CE/UE (secondo la pubblicazione nella Gazzetta ufficiale della Commissione europea):

Машина, указанная выше, полностью соответствует следующим регламентам ЕС/EU (опубликованным в Официальном журнале Европейского Содружества):

- **2006/42/EC**
Maschinenrichtlinie 2006/42/EG / Machinery directive 2006/42/EC / Directive Machines 2006/42/EC / Directiva 2006/42/CE (Máquinas) / Direttiva macchine 2006/42/CE / Директива о машинах 2006/42/EC
- **2014/30/EU**
EMV-Richtlinie 2014/30/EU / EMC Directive 2014/30/EU / Directive CEM 2014/30/UE / Directiva CEM 2014/30/UE / Direttiva EMC 2014/30/UE / Директива ЭМС 2014/30/EU
- **2011/65/EU, (EU) 2015/863**
RoHS-Richtlinien 2011/65/EU und (EU) 2015/863 / RoHS Directives 2011/65/EU and (EU) 2015/863 / Directives RoHS 2011/65/UE et (UE) 2015/863 / Directivas RoHS 2011/65/UE y (UE) 2015/863 / Direttive RoHS 2011/65/UE et (UE) 2015/863 / Директивы RoHS 2011/65/EU и (EU) 2015/863

1 / 3

Die oben beschriebenen Maschinen entsprechen aufgrund ihrer Konzipierung und Bauart sowie in der von uns in Verkehr gebrachten Ausführung den einschlägigen grundlegenden Sicherheits- und Gesundheitsanforderungen der genannten EG/EU-Richtlinien.

The machines described above are conform to the mentioned EC/EU directives in regard to the relevant safety and health demands due to their conception and style of construction as well as to the version put onto market by us.

Les machines décrites ci-dessus correspondent aux demandes de sécurité et de santé des directives citées de la CE/UE due à leur conception et construction et dans la réalisation mise sur le marché par nous.

Las máquinas descritas arriba se corresponden con los requisitos básicos pertinentes de seguridad y salud de las citadas directivas de la CE/UE debido a su concepción y fabricación, así como a la realización llevada a cabo por nosotros.

Le macchine sopra descritte sono conforme ai requisiti essenziali di sanità e sicurezza pertinenti delle summenzionate direttive CE/UE in termini di progettazione, tipo di costruzione ed esecuzione messa da noi in circolazione.

Машины описано выше, соответствует указанным директивам EC/EU в отношении требований соответствующей безопасности и здоровья по концепции и конструкции так же как и версия, применяемая нами на рынке.

Die oben beschriebenen Maschinen tragen entsprechend die Kennzeichnung CE.

The machines described above, corresponding to this, bear the CE-mark.

Les machines décrits ci-dessus, en correspondance, portent l'indication CE.

Las máquinas descritas arriba, en conformidad, llevan la indicación CE.

Le macchine sopra descritte sono contrassegnate dal marchio CE.

Машины описано выше, в соответствии с изложенным выше маркированы знаком CE.

Die oben beschriebenen Maschinen sind konform mit folgenden harmonisierten Normen:

The machines described above are in conformity with the following harmonized standards:

Les machines décrits ci-dessus sont conformes aux normes harmonisées suivantes:

Las máquinas descritas arriba cumplen con las siguientes normas:

Le macchine sopra descritte sono conforme alle seguenti normative armonizzate:

Машины описано выше, полностью соответствуют следующим стандартам:

Sicherheit / Safety / Sécurité / Seguridad / Sicurezza / Нормативы по безопасности

- **EN ISO 12100:2010 + Corr. 1:2011**
- **EN ISO 13732-1:2008**
- **EN 60204-1:2018**
- **EN 1539:2015**
- **EN ISO 13849-1:2015**

2 / 3

BINDER GmbH Postfach 102 D-78502 Tuttlingen Anschrift: BINDER GmbH Im Mittleren Ösch 5 D-78532 Tuttlingen
Kontakt: Telefon: +49 (0) 74 62 / 20 05 – 0 | Telefax: +49 (0) 74 62 / 20 05 – 100 | info@binder-world.com | www.binder-world.com
Geschäftsführung: Dipl.-Ing. Peter M. Binder | Amtsgericht Stuttgart, HRB 727150 | Sitz der Gesellschaft: Tuttlingen
Bankverbindung: Kreissparkasse Tuttlingen IBAN-Code: DE05643 500700 000002266 | SWIFT-Code: SOLA DE S1TUT
Deutsche Bank Tuttlingen IBAN-Code: DE56653 70075 0213870900 | SWIFT-Code: DEUT DE **SS653**
Altgeräte-Entsorgung gemäß WEEE-Reg.-Nr. DE 37004983

EMV / EMC / CEM / CEM / EMC / ЭМС
• EN 61326-1:2013
RoHS
• EN IEC 63000:2018

78532 Tuttlingen, 13.01.2022
BINDER GmbH



P. Wimmer
Vice President
Vice President
Vice président
Vicepresidente
vicepresidente
Вице-президент



J. Bollaender
Leiter F & E
Director R & D
Chef de service R&D
Responsable I & D
Direttore R & D
Глава департамента R&D

3 / 3

BINDER GmbH Postfach 102 D-78502 Tuttlingen Anschrift: BINDER GmbH Im Mittleren Ösch 5 D-78532 Tuttlingen
Kontakt: Telefon: +49 (0) 74 62 / 20 05 – 0 | Telefax: +49 (0) 74 62 / 20 05 – 100 | info@binder-world.com | www.binder-world.com
Geschäftsführung: Dipl.-Ing. Peter M. Binder | Amtsgericht Stuttgart, HRB 727150 | Sitz der Gesellschaft: Tuttlingen
Bankverbindung: Kreissparkasse Tuttlingen IBAN-Code: DE05643 500700 000002266 | SWIFT-Code: SOLA DE S1TUT
Deutsche Bank Tuttlingen IBAN-Code: DE56653 70075 0213870900 | SWIFT-Code: DEUT DE SS653
Allgeräte-Entsorgung gemäß WEEE-Reg.-Nr. DE 37004983

18.2 Certificate for the GS mark of conformity of the “Deutsche Gesetzliche Unfallversicherung e.V.” (German Social Accident Insurance (DGUV))

certificate no. OA 192001 dated 2019-01-29



Translation In any case, the German original shall prevail.

GS Certificate

Name and address of the holder of the certificate: (customer) Binder GmbH
 Im Mittleren Ösch 5
 78532 Tuttlingen
 GERMANY

Product designation: **Varnish drying cabinet**

Type: FDL 115

Testing based on: GS-OA-02:2015-09 Principles for testing and certification of dryers

Test report: Reference number 18.10.01 from 2019-01-21

Further details: Drying and stoving of varnishes and similar liquid coating materials
 Specific application options included:
 - external enabling via DIN jack with indicator light
 - supply with 3-pol CEE plug, 16A
 - feedthrough on the back, silicon plug included

This certificate replaces the certificate OA 142001 from 2017-09-15

The type tested meets the requirements specified in article 21 para. 1 of the German Product Safety Act. The holder of the certificate is entitled to affix the GS mark shown overleaf to the products complying with the type tested. At that, the holder of the certificate shall observe the conditions specified overleaf.

The present certificate including the right to affix the GS mark is valid until: **2024-01-28**

Further provisions concerning the validity, the extension of the validity and other conditions are laid down in the Rules of Procedure for Testing and Certification.



Dipl.-Wirt.-Ing. Christian Adler

Deutsche Gesetzliche Unfallversicherung (DGUV) e.V.
 Spitzenverband der gewerblichen Berufsgenossenschaften
 und der Unfallversicherungsträger der öffentlichen Hand
 Vereinsregister-Nr. VR 751 B, Amtsgericht Charlottenburg
 PZB04E
 01.18

DGUV Test Prüf- und Zertifizierungsstelle Oberflächentechnik und Anschlagmittel
 Fachbereich Holz und Metall
 Seligmannallee 4 • 30173 Hannover • Deutschland
 Telefon: +49 (0) 5 11 81 18-15048 • Fax: +49 (0) 5 11 81 18-25048



Reverse side of the GS Certificate OA 192001

GS mark



Standard design



Approved design for a height of 20 mm or less:

1. The holder of the certificate shall comply with the conditions to be observed in the production of the product specified overleaf in order to ensure conformity with the tested type.
2. The Testing and Certification Body shall, in regular intervals, carry out control measures for monitoring the production and the correct application of the GS mark.
3. The person responsible for the production has been obliged to observe the conditions according to 1. and to accept the control measures.
4. The Testing and Certification Body shall withdraw the allocation of the GS mark from the holder of the certificate if the requirements according to article 21 para. 1 of the German Product Safety Act are modified or the conditions according to 1. are not met.
5. The GS mark shall only be applied and it shall only be used in advertising, if the conditions according to article 22 of the German Product Safety Act are met.

19. Contamination clearance certificate

Unbedenklichkeitsbescheinigung

19.1 For chambers located outside USA and Canada

Declaration regarding safety and health

Erklärung zur Sicherheit and gesundheitlichen Unbedenklichkeit

The German Ordinance on Hazardous Substances (GefStofV), and the regulations regarding safety at the workplace, require that this form be filled out for all products that are returned to us, so that the safety and the health of our employees can be guaranteed.

Die Sicherheit und Gesundheit unserer Mitarbeiter, die Gefahrstoffverordnung GefStofV und die Vorschriften zur Sicherheit am Arbeitsplatz machen es erforderlich, dass dieses Formblatt für alle Produkte, die an uns zurückgeschickt wird.



Note: A repair is not possible without a completely filled out form.
Ohne Vorliegen des vollständig ausgefüllten Formblattes ist eine Reparatur nicht möglich.

- A completely filled out form must be transmitted via Fax (+49 (0) 7462 2005 93555) or by letter in advance, so that this information is available before the equipment/component part arrives. A second copy of this form must accompany the equipment/component part. In addition, the carrier should be notified.

Eine vollständig ausgefüllte Kopie dieses Formblattes soll per Telefax (Nr. +49 (0) 7462 2005 93555) oder Brief vorab an uns gesandt werden, so dass die Information vorliegt, bevor das Gerät/Bauteil eintrifft. Eine weitere Kopie soll dem Gerät/Bauteil beigelegt sein. Ggf. ist auch die Spedition zu informieren.

- Incomplete information or non-conformity with this procedure will inevitably lead to substantial delays in processing. Please understand the reason for this measure, which lies outside our area of influence and will help us to speed up this procedure.

Unvollständige Angaben oder Nichteinhalten dieses Ablaufs führen zwangsläufig zu beträchtlichen Verzögerungen in der Abwicklung. Bitte haben Sie Verständnis für Maßnahmen, die außerhalb unserer Einflussmöglichkeiten liegen und helfen Sie mit, den Ablauf beschleunigen.

- **Please print and fill out this form completely.**

Bitte unbedingt vollständig ausfüllen!

1.	Unit/ component part / type: / Gerät / Bauteil / Typ:
2.	Serial No./ Serien-Nr.:
3.	Details about utilized substances / biological substances / Einzelheiten über die eingesetzten Substanzen/biologische Materialien:
3.1	Designations / Bezeichnungen:
a)	_____
b)	_____
c)	_____
3.2	Safety measures required for handling these substances / Vorsichtsmaßnahmen beim Umgang mit diesen Stoffen:
a)	_____
b)	_____
c)	_____

3.3	Measures to be taken in case of skin contact or release into the atmosphere / Maßnahmen bei Personenkontakt oder Freisetzung:
a)	_____
b)	_____
c)	_____
d)	_____
3.4	Other important information that must be taken into account / Weitere zu beachtende und wichtige Informationen:
a)	_____
b)	_____
c)	_____
4.	Declaration on the risk of these substances (please checkmark the applicable items) / Erklärung zur Gefährlichkeit der Stoffe (bitte Zutreffendes ankreuzen) :
<input type="checkbox"/>	4.1 For non toxic, non radioactive, biologically harmless materials / für nicht giftige, nicht radioaktive, biologisch ungefährliche Stoffe:
	We hereby guarantee that the above-mentioned unit / component part... / Wir versichern, dass o.g. Gerät/Bauteil...
<input type="checkbox"/>	Has not been exposed to or contains any toxic or otherwise hazardous substances / weder giftige noch sonstige gefährliche Stoffe enthält oder solche anhaften.
<input type="checkbox"/>	That eventually generated reaction products are non-toxic and also do not represent a hazard / auch evtl. entstandene Reaktionsprodukte weder giftig sind noch sonst eine Gefährdung darstellen.
<input type="checkbox"/>	Eventual residues of hazardous substances have been removed / evtl. Rückstände von Gefahrstoffen entfernt wurden.
<input type="checkbox"/>	4.2 For toxic, radioactive, biologically harmful or hazardous substances, or any other hazardous materials / für giftige, radioaktive, biologisch bedenkliche bzw. gefährliche Stoffe oder anderweitig gefährliche Stoffe.
	We hereby guarantee that ... / Wir versichern, dass ...
<input type="checkbox"/>	The hazardous substances, which have come into contact with the above-mentioned equipment/component part, have been completely listed under item 3.1 and that all information in this regard is complete / die gefährlichen Stoffe, die mit dem o.g. Gerät/Bauteil in Kontakt kamen, in 3.1 aufgelistet sind und alle Angaben vollständig sind.
<input type="checkbox"/>	That the unit /component part has not been in contact with radioactivity / das Gerät/Bauteil nicht mit Radioaktivität in Berührung kam
5.	Kind of transport / transporter / Transportweg/Spediteur:
	Transport by (means and name of transport company, etc.) / Versendung durch (Name Spediteur o.ä.)

	Date of dispatch to BINDER GmbH / Tag der Absendung an BINDER GmbH:

We hereby declare that the following measures have been taken / Wir erklären, dass folgende Maßnahmen getroffen wurden:

- Hazardous substances were removed from the unit including component parts, so that no hazard exists for any person in the handling or repair of these items / das Gerät/Bauteil wurde von Gefahrstoffen befreit, so dass bei Handhabung/Reparaturen für die betreffenden Person keinerlei Gefährdung besteht
- The unit was securely packaged and properly identified / das Gerät wurde sicher verpackt und vollständig gekennzeichnet.
- Information about the hazardousness of the shipment (if required) has been provided to the transporter / der Spediteur wurde (falls vorgeschrieben) über die Gefährlichkeit der Sendung informiert.

We hereby commit ourselves and guarantee that we will indemnify BINDER GmbH for all damages that are a consequence of incomplete or incorrect information provided by us, and that we will exempt BINDER GmbH from eventual damage claims by third parties. / Wir versichern, dass wir gegenüber BINDER für jeden Schaden, der durch unvollständige und unrichtige Angaben entsteht, haften und BINDER gegen eventuell entstehende Schadensansprüche Dritter freistellen.

We are aware that, in accordance with Article 823 of the German Civil Code (BGB), we are directly liable with regard to third parties, in this instance especially the employees of BINDER GmbH, who have been entrusted with the handling / repair of the unit / component. / Es ist uns bekannt, dass wir gegenüber Dritten – hier insbesondere mit der Handhabung/Reparatur des Geräts/des Bauteils betraute Mitarbeiter der Firma BINDER - gemäß §823 BGB direkt haften

Name: _____

Position/Title: _____

Date / Datum: _____

Signature / Unterschrift: _____

Company stamp / Firmenstempel:



Equipment that is returned to the factory for repair must be accompanied by a completely filled out contamination clearance certificate. For service and maintenance on site, such a contamination clearance certificate must be submitted to the service technician before the start of any work. No repair or maintenance of the equipment is possible, without a properly filled out contamination clearance certificate.

19.2 For chambers in USA and Canada

Product Return Authorization Request

Please complete this form and the Customer Decontamination Declaration (next 2 pages) and attach the required pictures. E-mail to: IDL_SalesOrderProcessing_USA@binder-world.com

After we have received and reviewed the complete information we will decide on the issue of a RMA number. Please be aware that size specifications, voltage specifications as well as performance specifications are available on the internet at www.binder-world.us at any time.

Take notice of shipping laws and regulations.

	Please fill:	
Reason for return request	<input type="radio"/> Duplicate order	
	<input type="radio"/> Duplicate shipment	
	<input type="radio"/> Demo	<i>Page one completed by sales</i>
	<input type="radio"/> Power Plug / Voltage	115V / 230 V / 208 V / 240V
	<input type="radio"/> Size does not fit space	
	<input type="radio"/> Transport Damage	Shock watch tripped? (<i>pictures</i>)
	<input type="radio"/> Other (specify below)	

Is there a replacement PO?	<input type="radio"/> Yes <input type="radio"/> No	
<i>If yes -> PO #</i>		
<i>If yes -> Date PO placed</i>		
Purchase order number		
BINDER model number		
BINDER serial number		
Date unit was received		
Was the unit unboxed?	<input type="radio"/> Yes <input type="radio"/> No	
Was the unit plugged in?	<input type="radio"/> Yes <input type="radio"/> No	
Was the unit in operation?	<input type="radio"/> Yes <input type="radio"/> No	
<i>Pictures of unit attached?</i>	<input type="radio"/> Yes <input type="radio"/> No	Pictures have to be attached!
<i>Pictures of Packaging attached?</i>	<input type="radio"/> Yes <input type="radio"/> No	

	Customer Contact Information	Distributor Contact Information
Name		
Company		
Address		
Phone		
E-mail		

Customer (End User) Decontamination Declaration

Health and Hazard Safety declaration

To protect the health of our employees and the safety at the workplace, we require that this form is completed by the user for all products and parts that are returned to us. (Distributors or Service Organizations cannot sign this form)

	NO RMA number will be issued without a completed form. Products or parts returned to our NY warehouse without an RMA number will be refused at the dock.
---	--

A second copy of the completed form must be attached to the outside of the shipping box.

1.	Unit/ component part / type:
2.	Serial No.
3.	List any exposure to hazardous liquids, gasses or substances and radioactive material
3.1	List with MSDS sheets attached where available or needed (if there is not enough space available below, please attach a page):
a)	_____
b)	_____
c)	_____
3.2	Safety measures required for handling the list under 3.1
a)	_____
b)	_____
c)	_____
3.3	Measures to be taken in case of skin contact or release into the atmosphere:
a)	_____
b)	_____
c)	_____
d)	_____
3.4	Other important information that must be considered:
a)	_____
b)	_____
c)	_____

4. Declaration of Decontamination

For toxic, radioactive, biologically and chemically harmful or hazardous substances, or any other hazardous materials.

We hereby guarantee that

- 4.1 Any hazardous substances, which have come into contact with the above-mentioned equipment / component part, have been completely listed under item 3.1 and that all information in this regard is complete.
- 4.2 That the unit /component part has not been in contact with radioactivity
- 4.3 Any Hazardous substances were removed from the unit / component part, so that no hazard exists for a person in the shipping, handling or repair of these returned unit
- 4.4 The unit was securely packaged in the original undamaged packaging and properly identified on the outside of the packaging material with the unit designation, the RMA number and a copy of this declaration.
- 4.5 Shipping laws and regulations have not been violated.

I hereby commit and guarantee that we will indemnify BINDER Inc. for all damages that are a consequence of incomplete or incorrect information provided by us, and that we will indemnify and hold harmless BINDER Inc. from eventual damage claims by third parties.

Name: _____

Position: _____

Company: _____

Address: _____

Phone #: _____

Email: _____

Date: _____

Signature: _____



Equipment returned to the NY warehouse for repair must be accompanied by a completed customer decontamination declaration. For service and maintenance works on site, such a customer decontamination declaration must be submitted to the service technician before the start of work. No repair or maintenance of the equipment is possible without a completed form.